

Internet Programmable Thermostat with CO2 and Humidity TS250H



Before Removing the Old Thermostat!

Note the wire colors and letter designations of the existing thermostat to assist in identifying the correct wiring connections to the TS250H.



Caution



Failure to follow these instructions can damage the product or cause a hazardous condition. Disconnect power during the installation of this product. All wiring must conform to local codes and ordinances. We strongly recommend that any installation or servicing be performed by a qualified technician. This thermostat is designed for use with 24VAC systems only. For additional support contact Pelican Technical Support at 888-512-0490 or email support@pelicanwireless.com



WARNING

NEVER INSTALL THE PELICAN THERMOSTAT ENCLOSED IN METAL. WIRELESS CANNOT COMMUNICATE THROUGH METAL.

Thermostat Terminal Designations

Conventional Control

DATA	D	⊕
COMMON	C	⊕
24VAC (COOL)	R	⊕
24VAC (HEAT)	Rc	⊕
COOL STAGE 1	Y	⊕
HEAT STAGE 1	W	⊕
FAN	G	⊕
HEAT STAGE 2	W2	⊕
COOL STAGE 2	Y2	⊕
HUMIDIFY	Hu	⊕
DE-HUMIDIFY	Dh	⊕

Heat Pump Control

DATA	D	⊕
COMMON	C	⊕
24VAC	R	⊕
24VAC	Rc	⊕
COMPRESSOR STAGE 1	Y	⊕
REVERSING VALVE (O/B)	W	⊕
FAN	G	⊕
AUXILIARY HEAT	W2	⊕
COMPRESSOR STAGE 2	Y2	⊕
HUMIDIFY	Hu	⊕
DE-HUMIDIFY	Dh	⊕

TS250H Mounting and Assembly

1

Grasp front and back of thermostat and firmly pull apart.

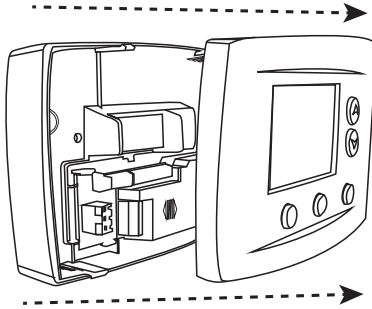

2

Remove old thermostat

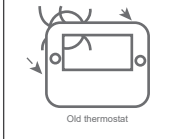

Mount thermostat rear cover to the wall.

Option One:

Mark mounting holes
drill two 3/16" holes in
wall. Insert drywall anchors
and use provided sheet metal
screws to attach rear
cover to wall.

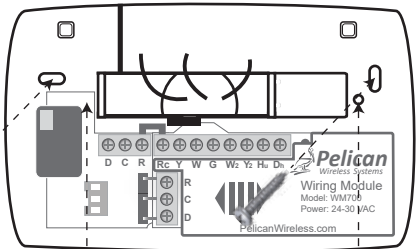

Option Two:

Mount rear cover on
horizontal two gang
electrical box. Use
included machine
screws.

TS250H Mounting and Assembly

3

Align three pin connector from thermostat front cover to three pin connector on rear cover. Push front cover onto rear cover until secure.

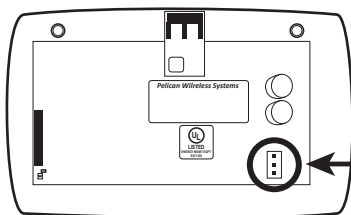

Thermostat Front Cover

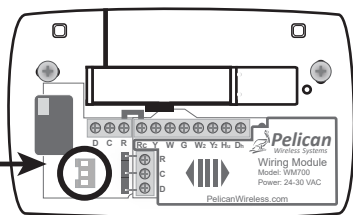

Thermostat Rear Cover

Optional Tamper Resistant Lock

The thermostat contains an internal locking mechanism to secure the front cover to the rear cover. This is intended to keep untrained individuals from tampering with the power and thermostat wire.

To engage the lock, assemble the thermostat and insert a 7/64" Allen wrench into the key hole on the top of the thermostat.

Rotate clockwise until reaching the stop to secure. Rotate counter-clockwise until reaching the stop to release.

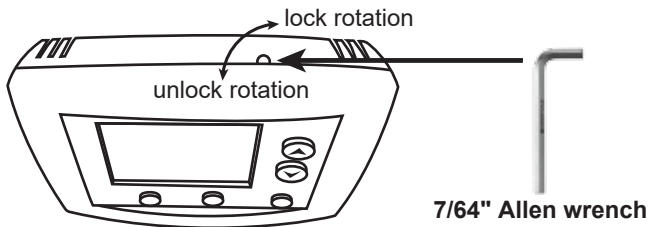

Conventional Wiring Guide

5 Wire, 24VAC Conventional 1 stage cooling with 1 stage heat

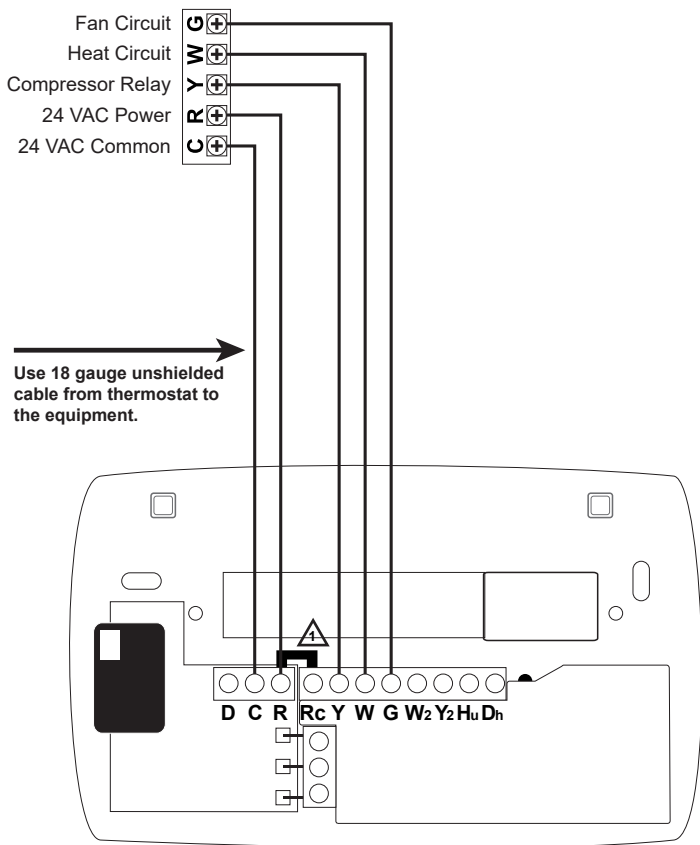

⚠ For a Two Transformer System – remove jumper between R and Rc. Connect the 24VAC power for energizing the unit's Compressor to thermostat's (R) terminal. Connect second 24VAC power to thermostat's (Rc) terminal.

Conventional Wiring Guide

6 Wire, 24VAC Conventional 1 stage cooling with 2 stage heat

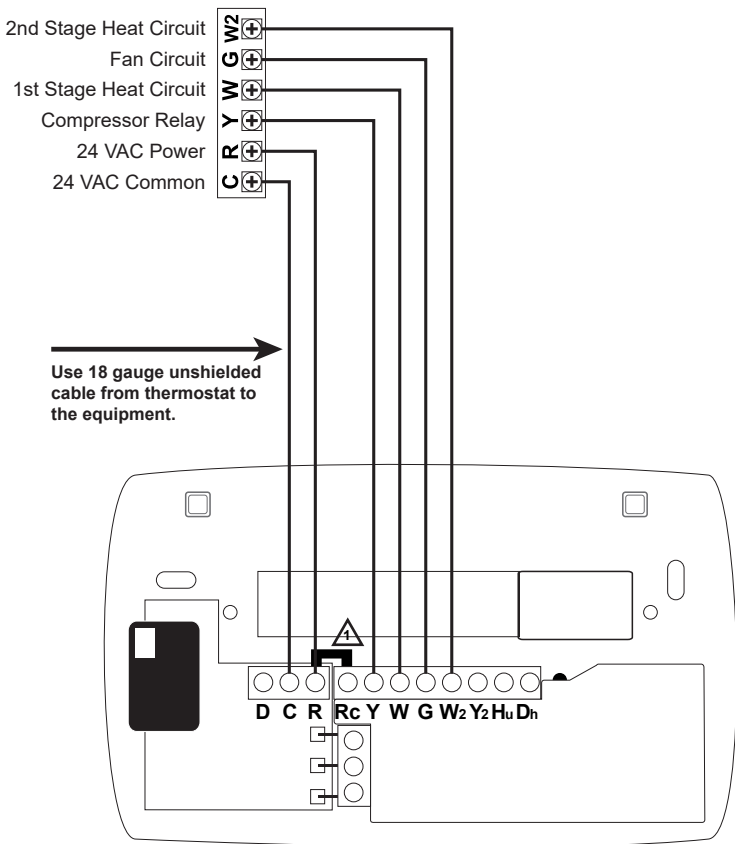

⚠ For a Two Transformer System – remove jumper between R and Rc. Connect the 24VAC power for energizing the unit's Compressor to thermostat's (R) terminal. Connect second 24VAC power to thermostat's (Rc) terminal.

Conventional Wiring Guide

6 Wire, 24VAC Conventional 2 stage cooling with 1 stage heat

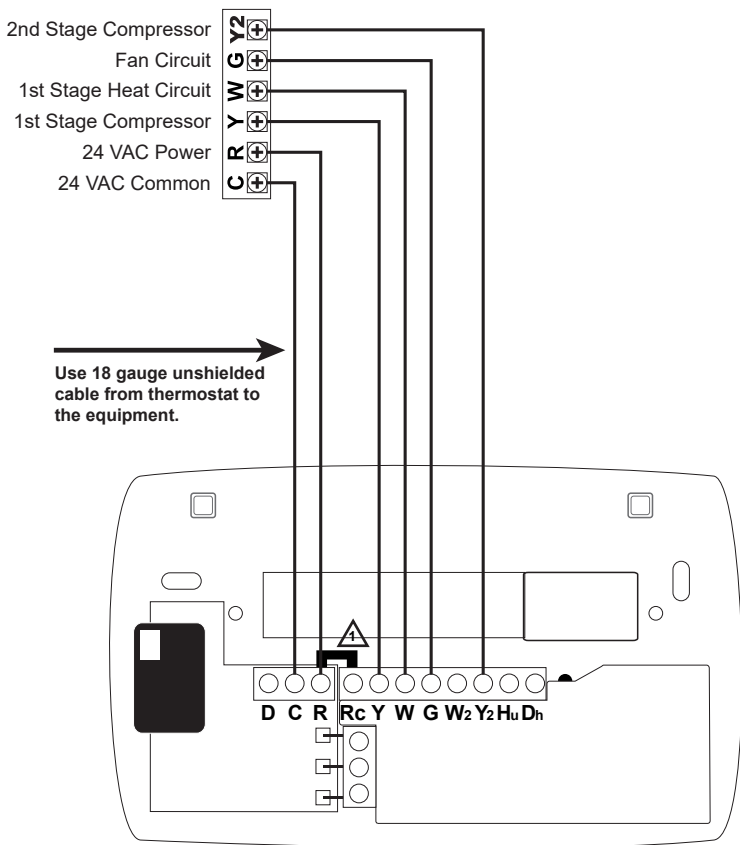

⚠ For a Two Transformer System – remove jumper between R and Rc. Connect the 24VAC power for energizing the unit's Compressor to thermostat's (R) terminal. Connect second 24VAC power to thermostat's (Rc) terminal.

Conventional Wiring Guide

7 Wire, 24VAC Conventional 2 stage cooling with 2 stage heat

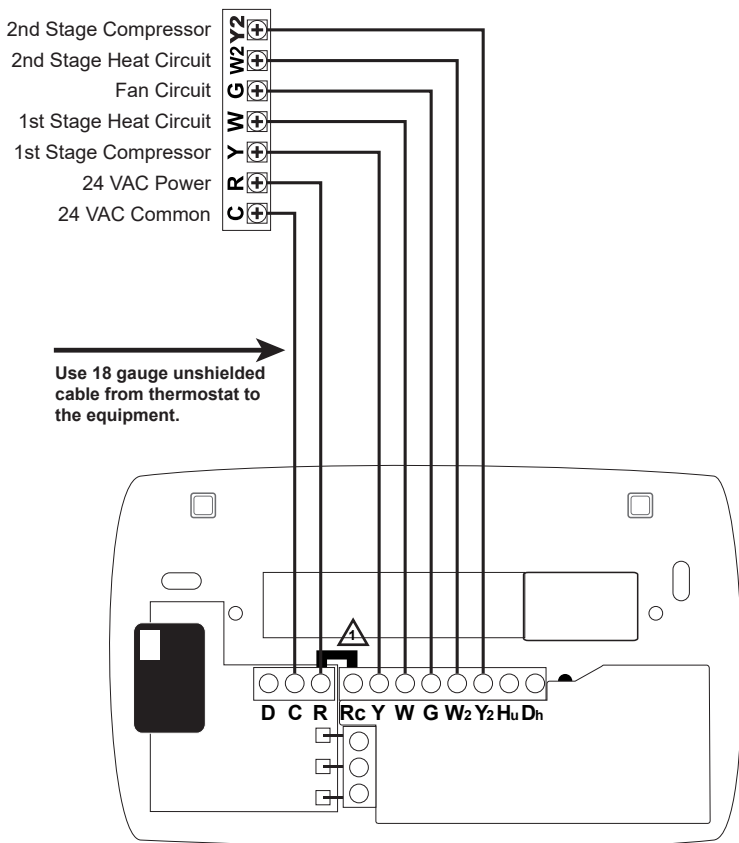

⚠ For a Two Transformer System – remove jumper between R and Rc. Connect the 24VAC power for energizing the unit's Compressor to thermostat's (R) terminal. Connect second 24VAC power to thermostat's (Rc) terminal.

Conventional Wiring Guide

7 Wire, 24VAC Conventional 1 stage cooling, 2 stage heat, and 2 fan speeds

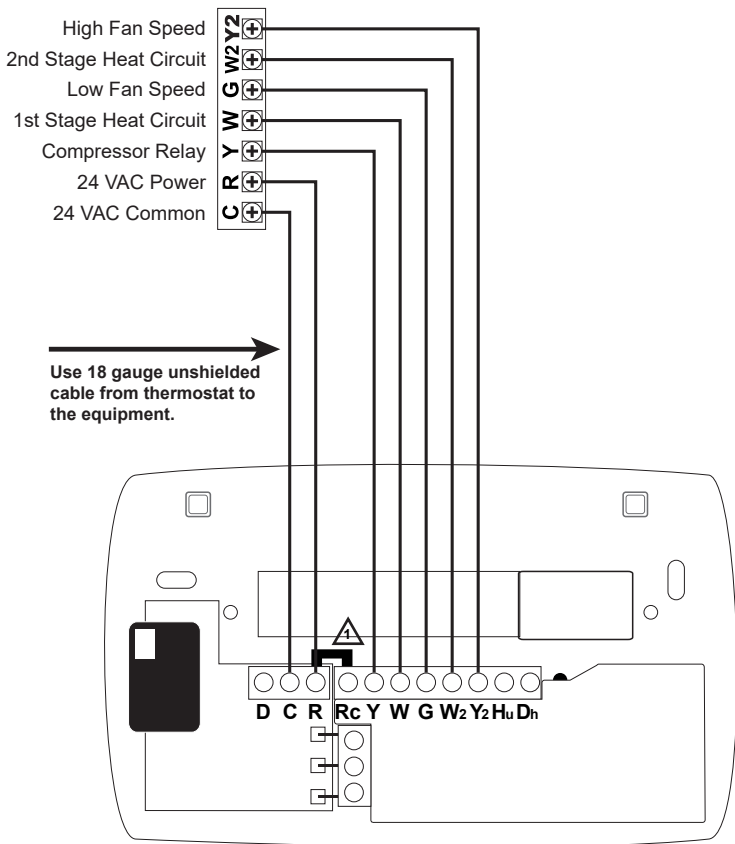

⚠ For a Two Transformer System – remove jumper between R and Rc. Connect the 24VAC power for energizing the unit's Compressor to thermostat's (R) terminal. Connect second 24VAC power to thermostat's (Rc) terminal.

Heat Pump Wiring Guide

5 Wire, 24VAC Heat Pump 1 stage cooling with 1 stage heat

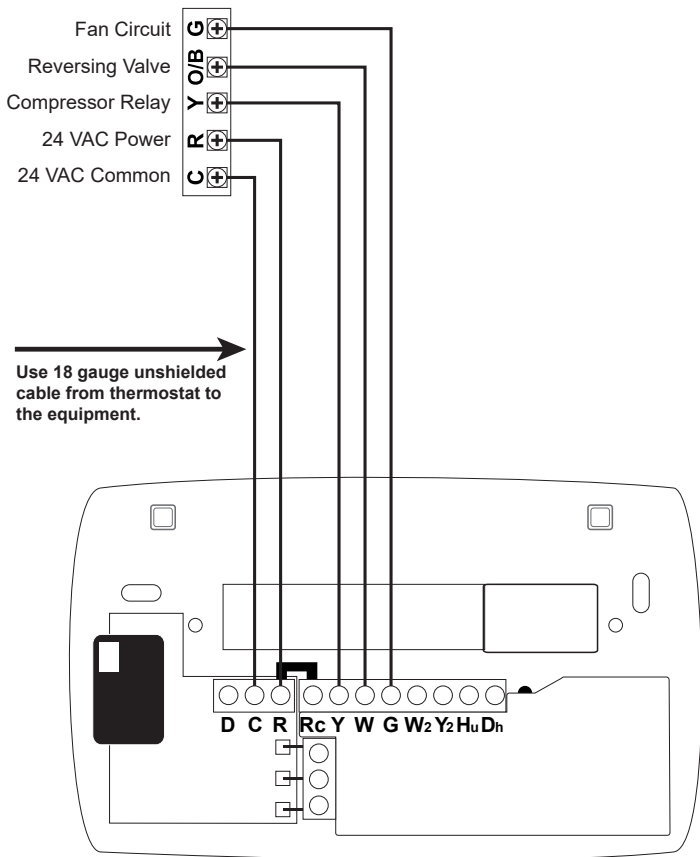

Heat Pump Wiring Guide

6 Wire, 24VAC Heat Pump 2 stage cooling with 2 stage heat

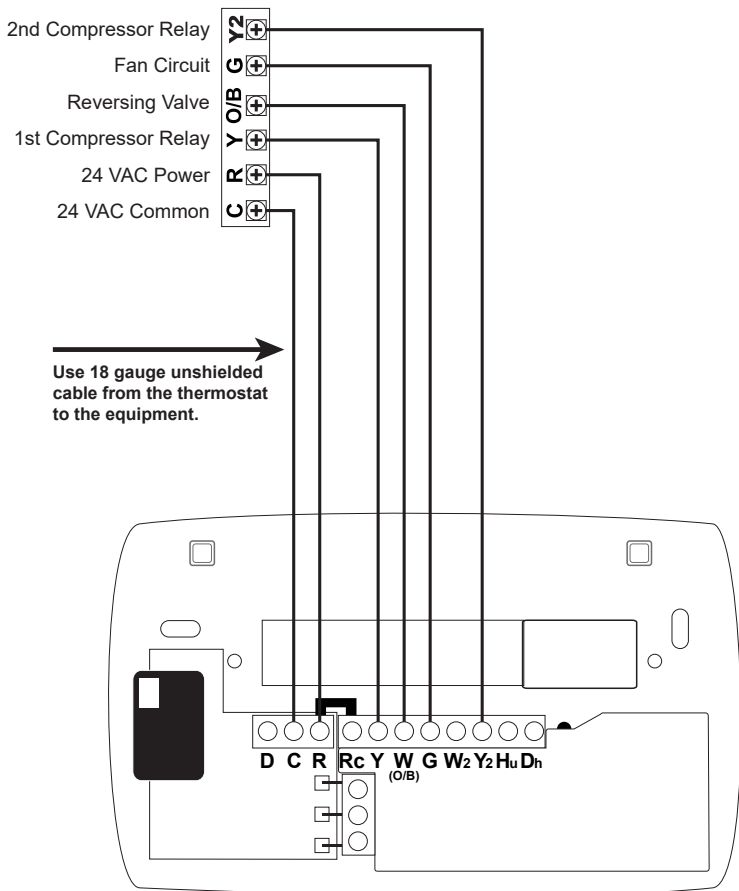

Heat Pump Wiring Guide

6 Wire, 24VAC Heat Pump 2 stage cooling, 1 stage heat and auxiliary/emergency heat

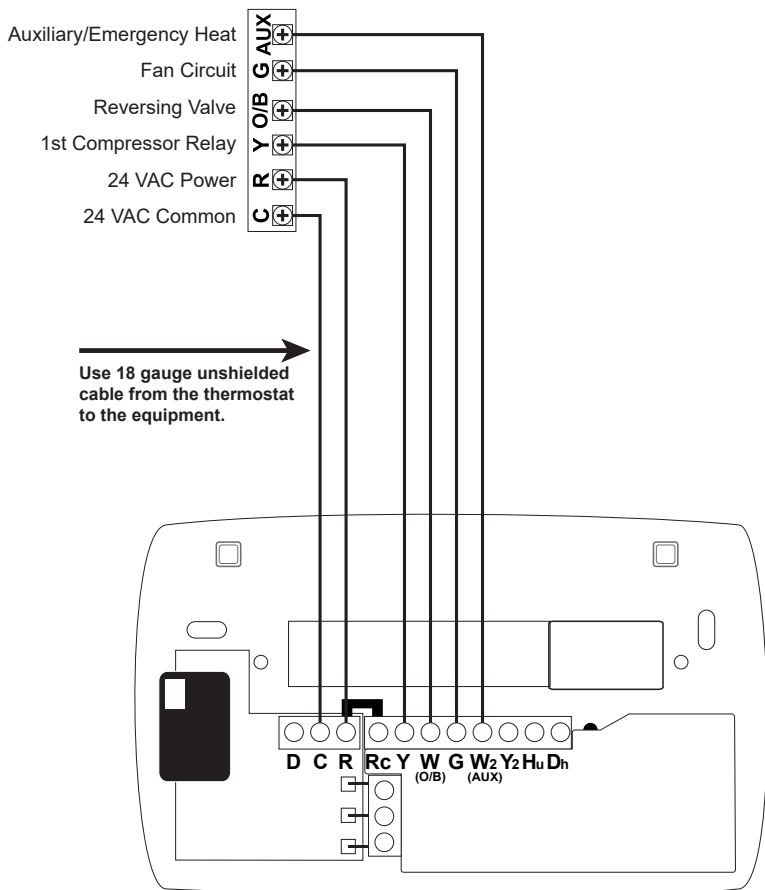

Heat Pump Wiring Guide

7 Wire, 24VAC Heat Pump 2 stage cooling, 2 stage heat and auxiliary/emergency heat

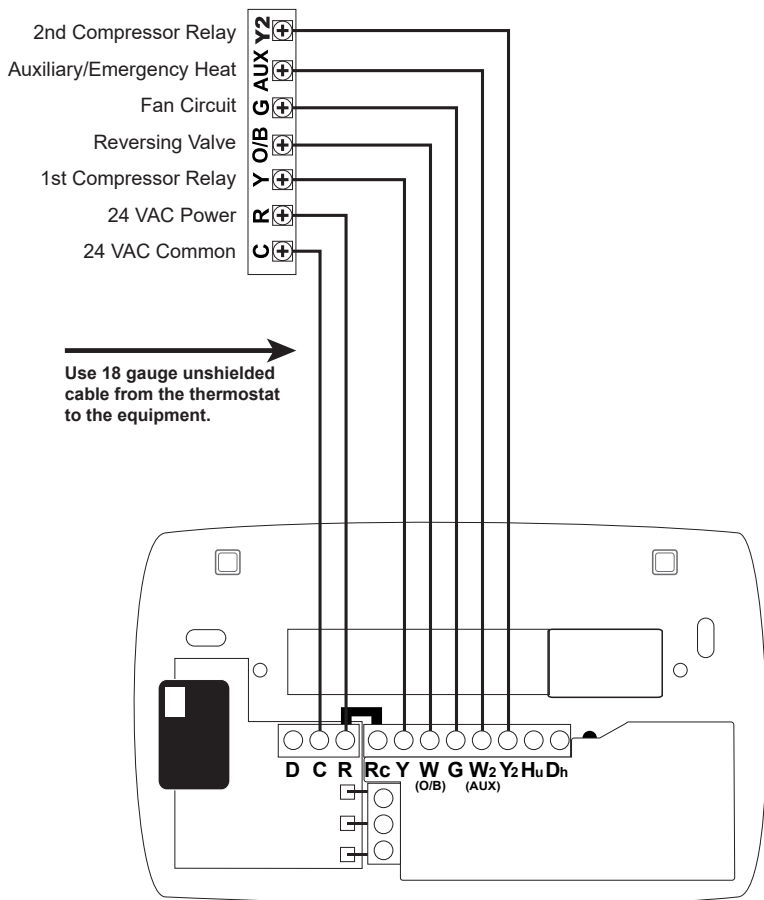

Heat Pump Wiring Guide

7 Wire, 24VAC Heat Pump 1 stage cooling, auxiliary/emergency heat, and 2 stage fan

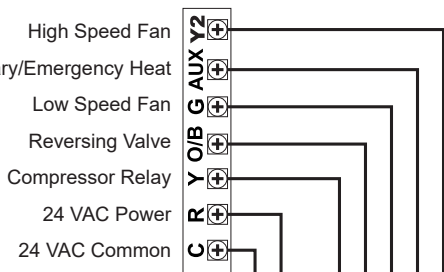

Use 18 gauge unshielded cable from the thermostat to the equipment.

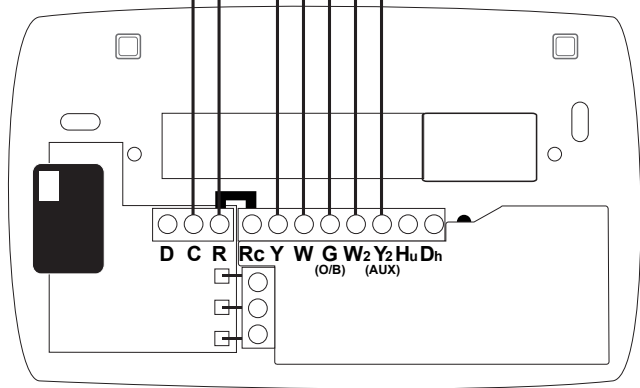

Humidifier Wiring Guide

24VAC Humidification Output

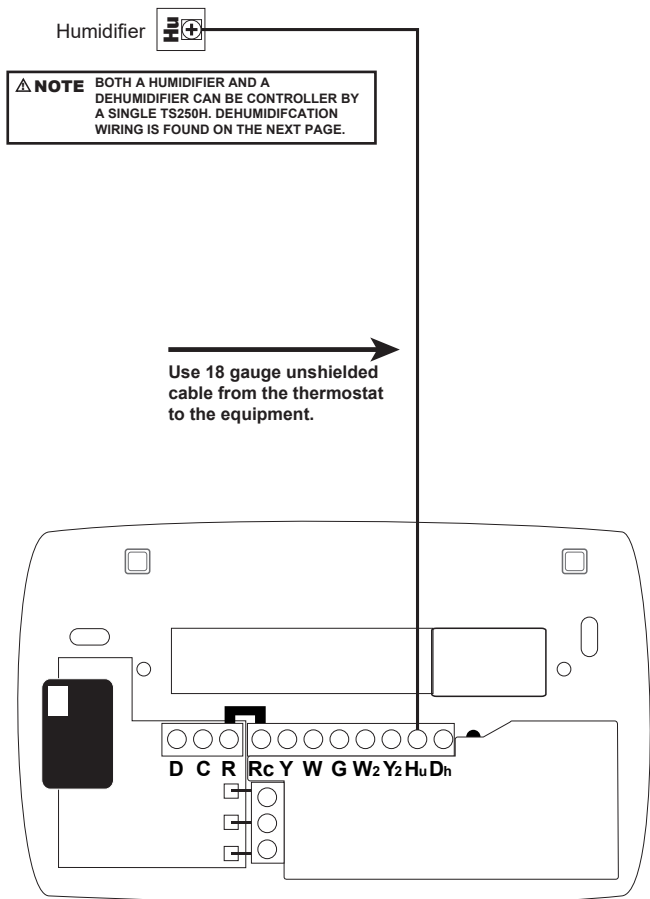

Dehumidifier Wiring Guide

24VAC Dehumidification Output

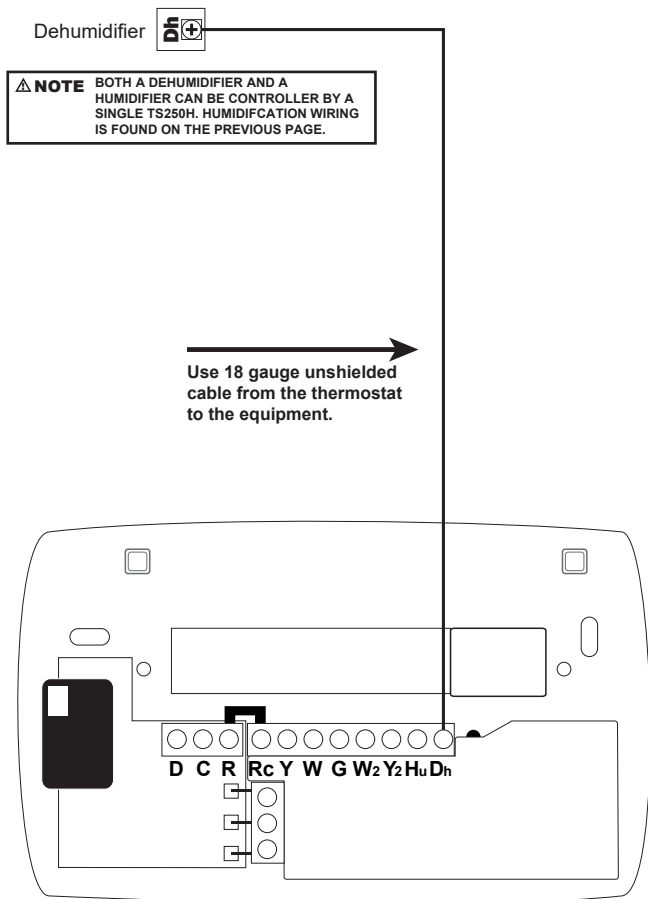

Optional Three Wire Installation

Some installations may have limited in-wall wire. In these cases, the TS250H can accommodate the use of only three wires and still provide control over the entire HVAC unit. To accomplish a three wire installation follow the steps outlined below:

1. Loosen R and Rc terminal screws to remove jumper.
2. Loosen R, C, and D terminal screws on the Wiring Module (WM700).
3. Gently slide the WM700 to the right and remove module from the rear of the thermostat. The WM700 will slide out with very little force.

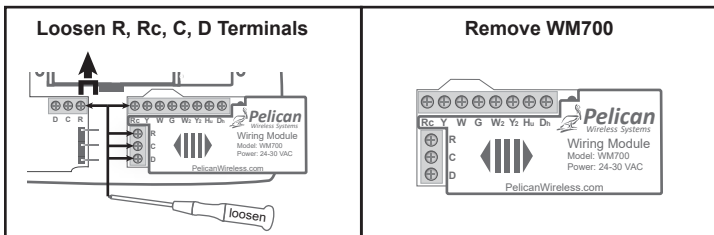

4. Mount the WM700 inside the HVAC unit. Follow the Wiring Guide section (pg. 4 – 13) of this installation guide for directions on how to wire the WM700 to your type of HVAC unit.

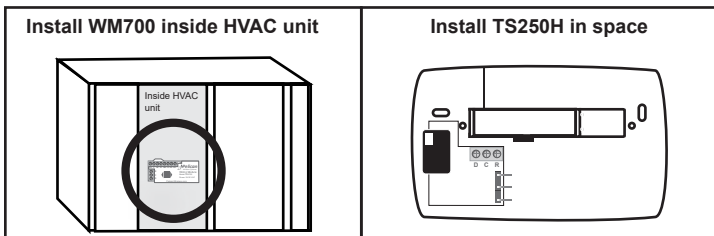

5. Use the existing in-wall 18 gauge unshielded wire to connect the R, C, D terminals from the WM700 to the matching R, C, D terminals at the thermostat

NOTE THE WIRING BELOW IS FOR A STANDARD FIVE (5) WIRE INSTALLATION. FOR DIFFERENT WIRING OPTIONS FOLLOW THE WIRING GUIDES FOUND IN THE PREVIOUS PAGES.

WM700 INSTALLED INSIDE HVAC UNIT

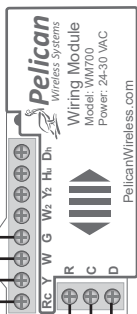

Fan Circuit
Heat Circuit
Compressor Relay
24 VAC Power
24 VAC Common

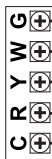

Use 18 gauge unshielded cable from WM700 to thermostat. Wire can be up to 500 feet in length.

THERMOSTAT INSTALLED IN SPACE

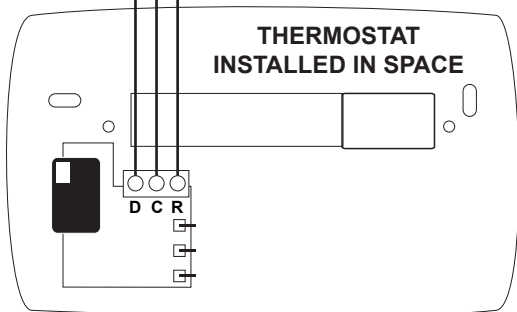

Thermostat Configuration

All configuration settings are made Online through the Pelican Web App. Each thermostat will automatically join the Pelican Web App and will be listed both as a notification and as a new thermostat under *Admin*. The thermostat is initially listed by it's serial number. Most configurable items can be left at their default settings. For proper operation it is necessary to set the correct System Type (Conventional or Heat Pump). If the Web App is not accessible, the thermostat's System Type can be set directly using the thermostat front keypad.

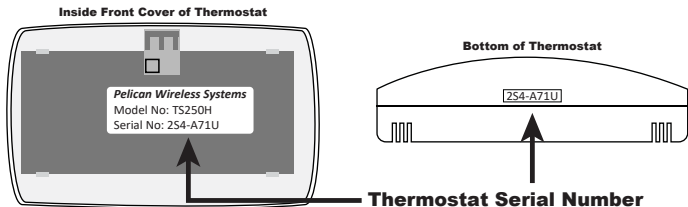

Setting System Type Using Thermostat Keypad

The thermostat can be placed into the correct system type (conventional or heat pump) during the first minute after the unit has been powered on. If the thermostat has been running for longer than one minute, remove the front cover of the thermostat from the rear base and then re-attach. This will cause it to recycle the power.

Within the first minute of the thermostat powered on, press and hold the up and down arrows simultaneously for five seconds. This will place the thermostat in configuration mode and the display will change to show one of the three possible system type settings:

Conventional System (Default)	CO
Heat Pump "W" Terminal Controls Reversing Valve. Energized for Cool.	HP 0
Heat Pump "W" Terminal Controls Reversing Valve. Energized for Heat.	HP b

The system type can be changed by pressing the **up arrow** on the thermostat. Once the correct setting is displayed, press any other button, the thermostat will save the setting and return to normal operation.

**This Page
Intentionally
Left Blank**

**Pelican Wireless Systems.
All Rights Reserved.**

**For More Information on Pelican Wireless Systems
Please Visit: www.pelicanwireless.com**



Pelican Wireless Systems, 2655 Collier Canyon Rd. Livermore, CA 94551

Phone: 888.512.0490

Email: support@pelicanwireless.com Website: www.PelicanWireless.com