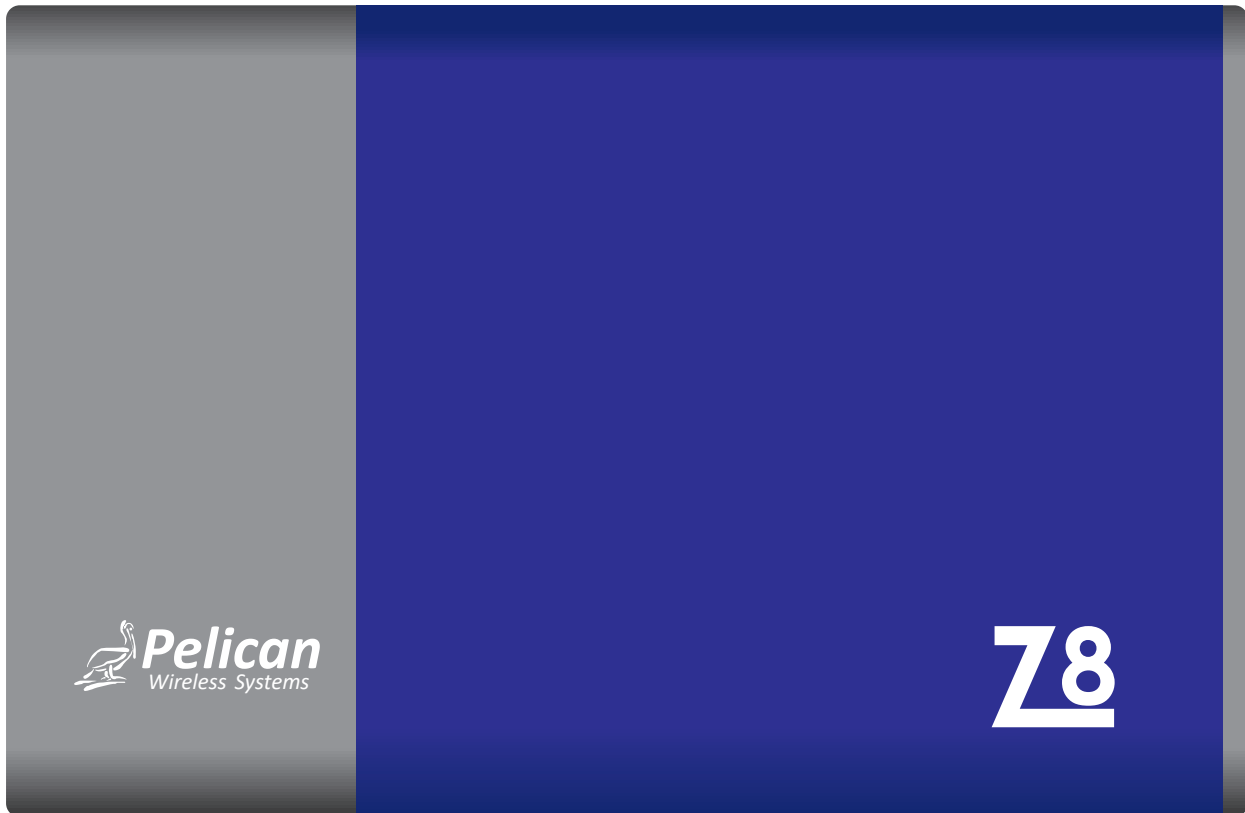




# Installation Guide

## Z8 Wireless Zone Controller



Pelican Wireless Systems, 2655 Collier Canyon Rd. Livermore, CA 94551

Phone: 888.512.0490

Email: [support@pelicanwireless.com](mailto:support@pelicanwireless.com) Website: [www.pelicanwireless.com](http://www.pelicanwireless.com)

# Table of Contents

Specifications .....	3
Provided Equipment .....	3
Terminal Designations .....	4
Installation .....	6
Installation Process .....	10
Mounting .....	12
Wireless Module .....	13
Conventional Wiring Diagrams	
Conventional System .....	15
Conventional System with Bypass .....	16
Conventional System with Bypass and Economizer .....	17
Conventional System with Variable Speed Fan (VFD) .....	18
Conventional System with Variable Speed Fan (VFD) and Economizer .....	19
Conventional System with Economizer .....	20
Heat Pump Wiring Diagrams	
Heat Pump .....	21
Heat Pump with Bypass .....	22
Heat Pump with Bypass and Economizer .....	23
Heat Pump with Variable Speed Fan (VFD) .....	24
Heat Pump with Variable Speed Fan (VFD) and Economizer .....	25
Heat Pump with Economizer .....	26
Boiler Wiring Diagram .....	27
Setup and Configuration .....	28
Troubleshooting .....	31

## GENERAL

The Pelican zone control solution uses strategic logic and built-in learning algorithms to properly condition spaces or areas of diverse load. The zone controller uses sensors and software to monitor temperatures and duct pressure to intelligently navigate complex building environments. The zone controller is a pressure dependent device that maintains space temperature by modulating the amount of supply airflow brought into different spaces. To aid in decision making, space or zone temperatures and total building load is continuously monitored and wirelessly communicated to the zone controller from Pelican thermostats installed through-out the building. During times when zones are being conditioned, rate of temperature change relative to set point is monitored and logic is dynamically adjusted. This data allows the zone controller to satisfy the temperature and ventilation requirements for each zone in a timely and energy efficient manner.

## PRE-INSTALLATION CONSIDERATIONS

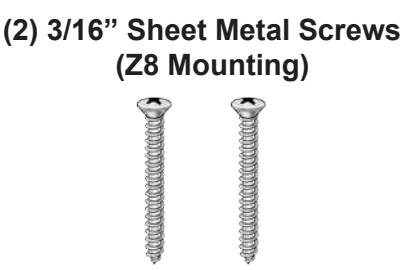
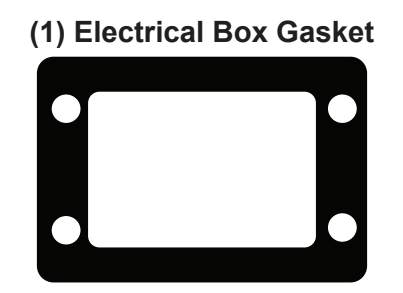
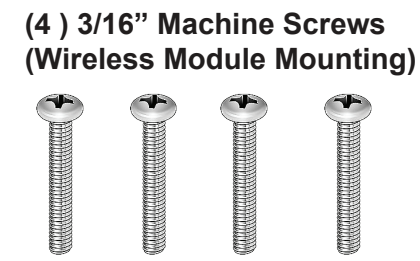
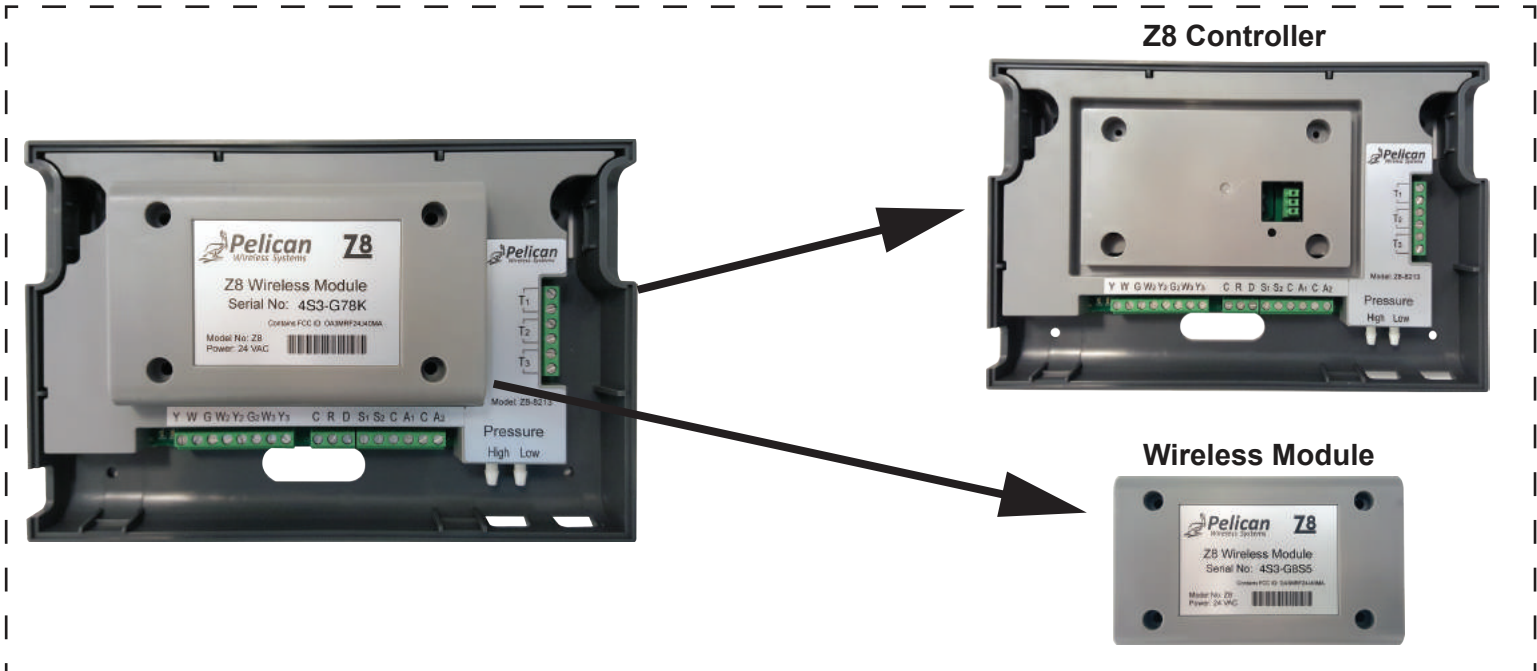
Before installing any zoning system forethought and planning should take place to identify which type of HVAC equipment the Z8 will be controlling, how many stages the equipment has, how many zones are going to be conditioned, and what the square footage of each zone is for the size of the HVAC equipment. Because the Z8 uses wireless communication, plan installation locations appropriately for each Pelican device. Contact Pelican Support at 888.512.0490 for further assistance.

# SPECIFICATIONS

## Electrical

Power .....	24 VAC
Relay Current .....	1 AMP @ 24V
Variable Output .....	0-10 VDC
Thermistor Input .....	10K Type II
Pressure Range .....	0 – 9" WC

## PROVIDED EQUIPMENT



# TERMINAL DESIGNATIONS

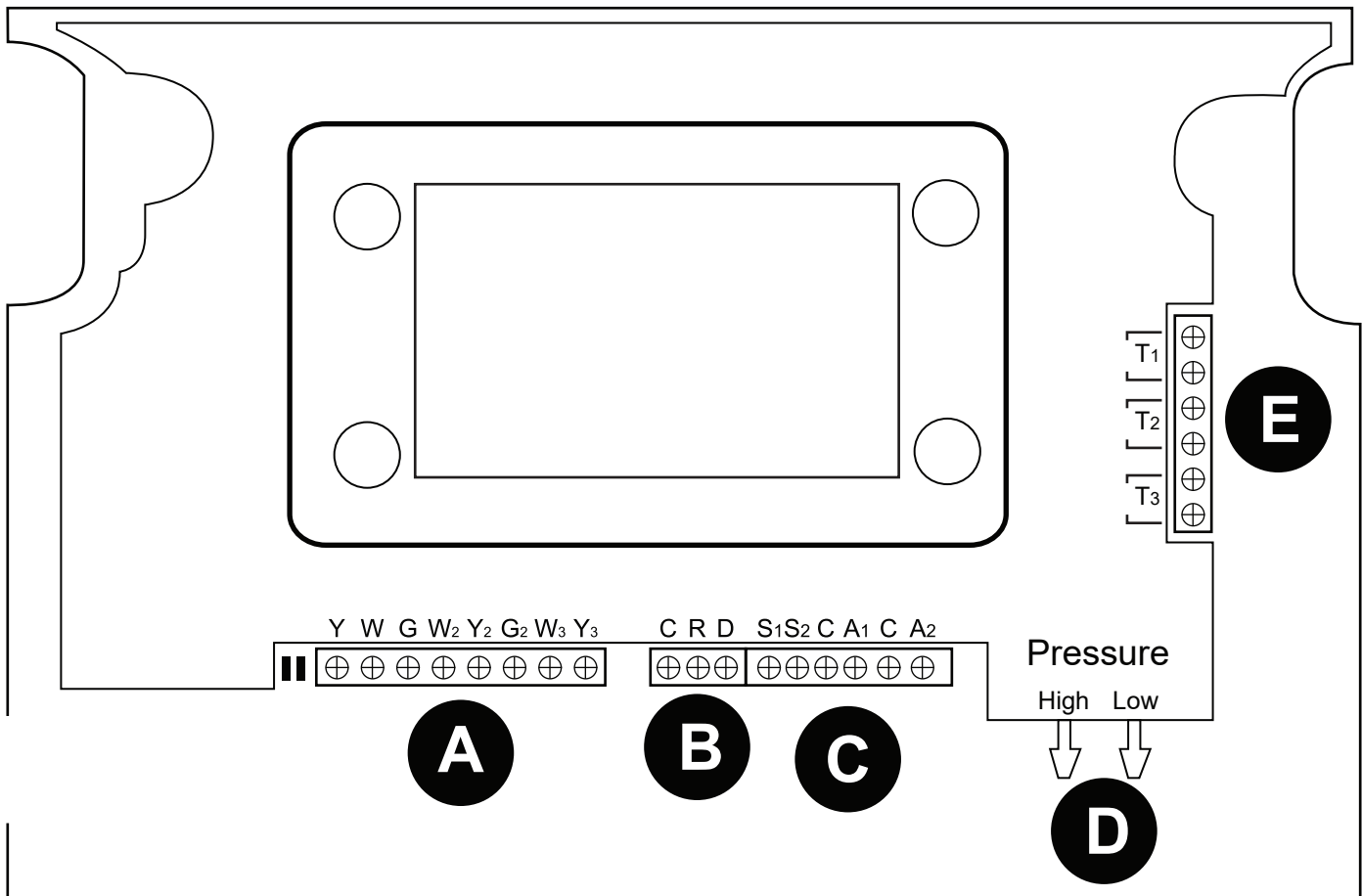


Fig. 1

## A HVAC UNIT CONTROL (24VAC Digital Outputs)

### Conventional

Y	Compressor Stage 1
W	Heat Stage 1
G	Fan Energize
W2	Heat Stage 2
Y2	Compressor Stage 2
G2	Exhaust Fan Energize
W3	Heat Stage 3
Y3	Compressor Stage 3

### Heat Pump

Y	Compressor Stage 1
W	(O/B) Reversing Valve
G	Fan Energize
W2	(AUX) Electric Heat
Y2	Compressor Stage 2
G2	Exhaust Fan Energize
W3	(Not Used)
Y3	Compressor Stage 3

## B ELECTRICAL CONNECTIONS

C	Common 24 VAC
R	24 VAC Power
D	Data

## D STATIC PRESSURE SENSOR

High	Duct Pressure
Low	Outside/Ambient Pressure

## C 0-10VDC INPUTS/OUTPUTS

S1	0-10 VDC input
S2	0-10 VDC input
C	Common
A1	0-10 VDC output
A2	0-10 VDC output

## E 10K ANALOG INPUTS

T1	Input Terminal
T2	Input Terminal
T3	Input Terminal

**Note:**

“T” Terminals can accept either Type 2 10K temperature probe or a Dry Contact Sensor input to send an alarm notification through your Pelican Site Manager.

## WHEN INSTALLING THIS PRODUCT...

1. Read these instructions carefully and thoroughly. Failure to follow these instructions or improper installation, service, adjustments, maintenance, and/or use can result in personal injury, damage to personal property, and/or cause a hazardous and dangerous situation.
2. Check the ratings and description given in this specification to make sure the product is suitable for your application.
3. Installer must be a trained and experienced technician. Follow all safety codes and regulations and all local and state building codes. Read instructions thoroughly and follow all warnings or notes.
4. After installation is complete, check product operation as provided in these instructions.

### CAUTION

---

1. Disconnect power supply before connecting any wiring to device to prevent electrical shock or damage to equipment.
  2. This guide is designed for certified, trained, and experienced service technicians. Failure to follow installation instructions does not alleviate installer responsibility to protect the equipment and property device is being connected too. If at anytime there becomes concern or confusion about how to install or use this device, immediately stop what you are doing and either contact Pelican Wireless Systems or a Pelican Wireless System's distributor.
- 

### WARNING

---

1. This equipment is designed to communicate over radio frequency to other Pelican equipment only. If this equipment is not installed and used in accordance with the instruction manual, you may experience wireless interference. This device has been tested and complies with FCC rules and regulations.
- 

## LOCATION AND MOUNTING

### Location

Choose a location for the Z8 that is not exposed to weather, and where controls and connections are accessible. The Wireless Module can be removed from the Z8 and is waterproof if installed onto a plastic electrical box with the provided gasket placed in-between (Reference Page 13). Gasket is required to create a water tight seal between Wireless Module and plastic electrical box (Reference Page 14).

### CAUTION

---

Always remove the Wireless Module if the Z8 is installed enclosed in metal (e.g. inside the HVAC unit). The Wireless Module will not be able to communicate if metal is blocking its signal.

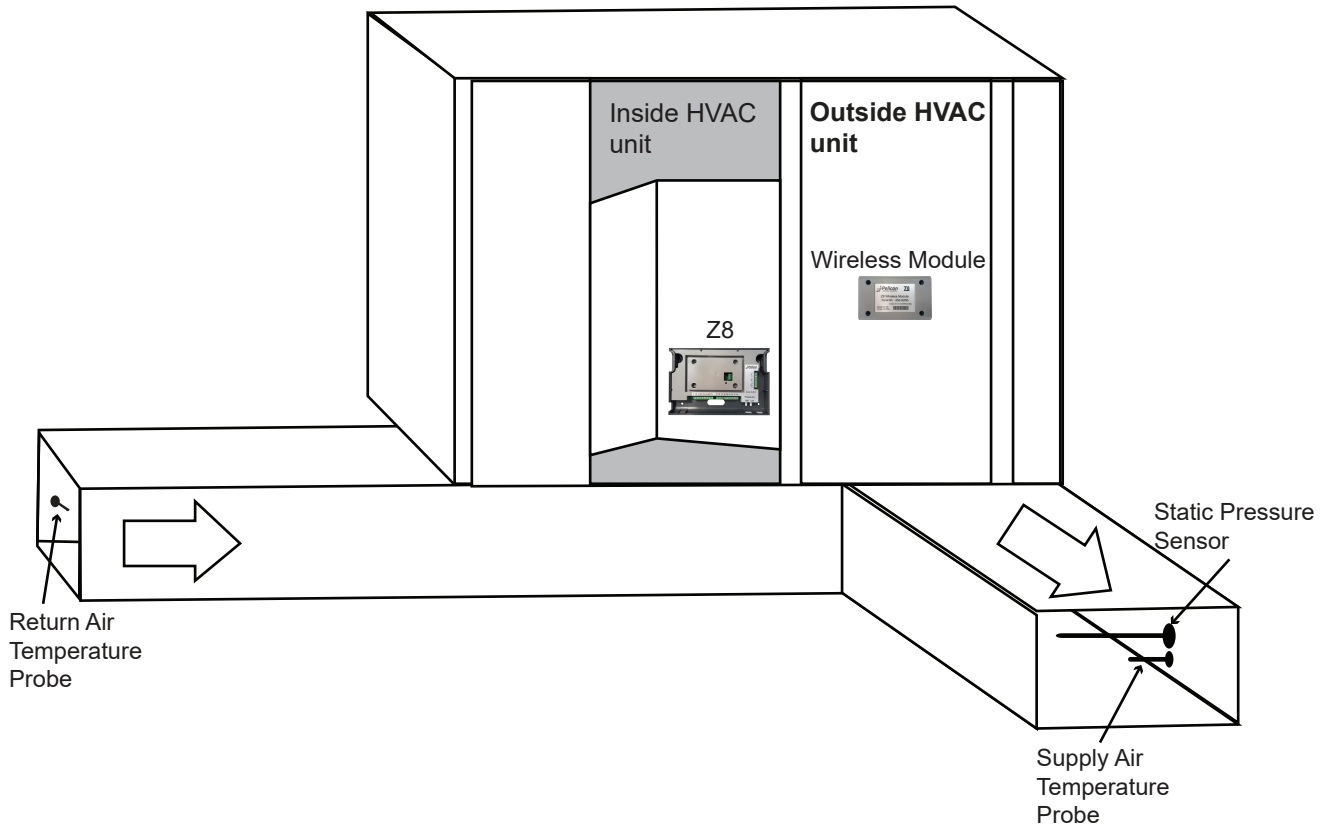
---

**! WARNING**

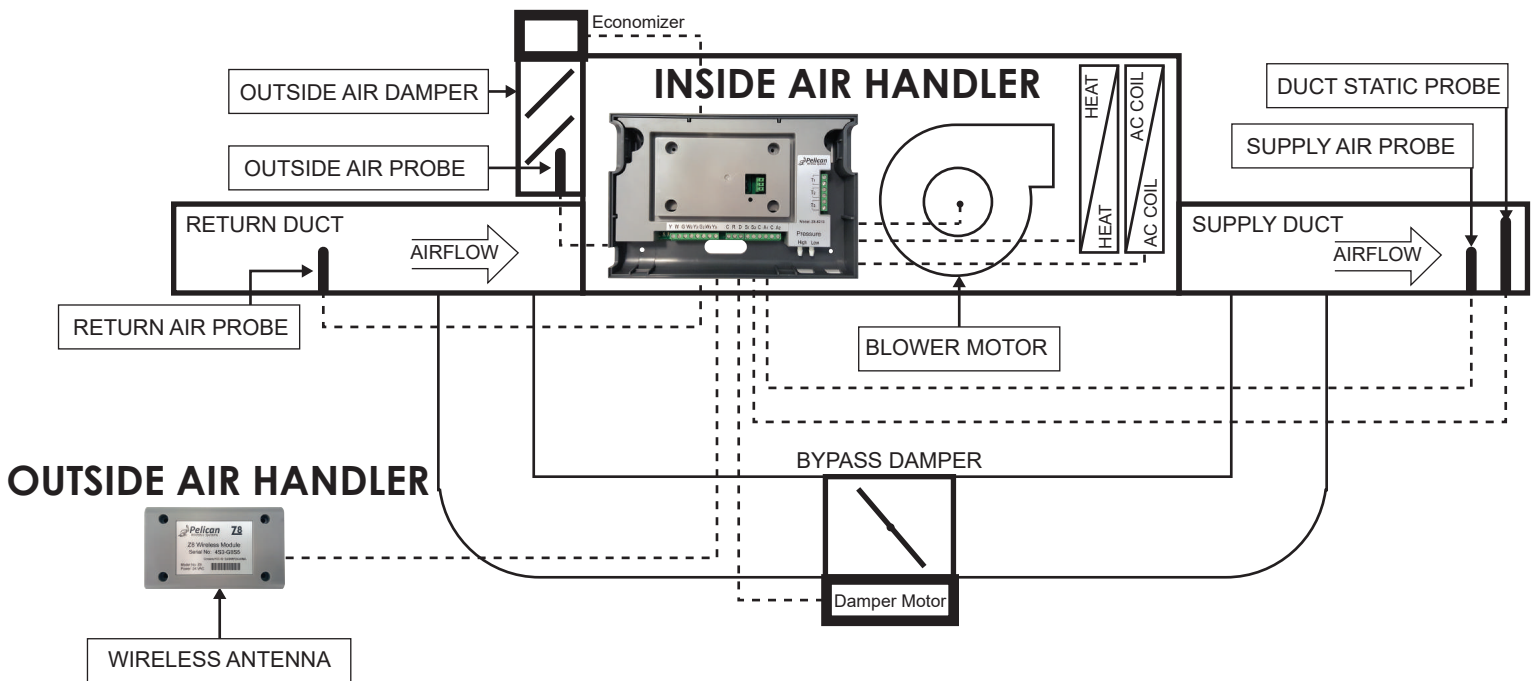
If installing the Wireless Module outside, make sure it is installed onto a PLASTIC electrical box. Make sure a proper seal is created between the Wireless Module, the provided gasket, and the contact edge of the plastic electrical box.

Mounting examples are shown below are for reference. Additional examples can be found at [www.pelicanwireless.com](http://www.pelicanwireless.com).

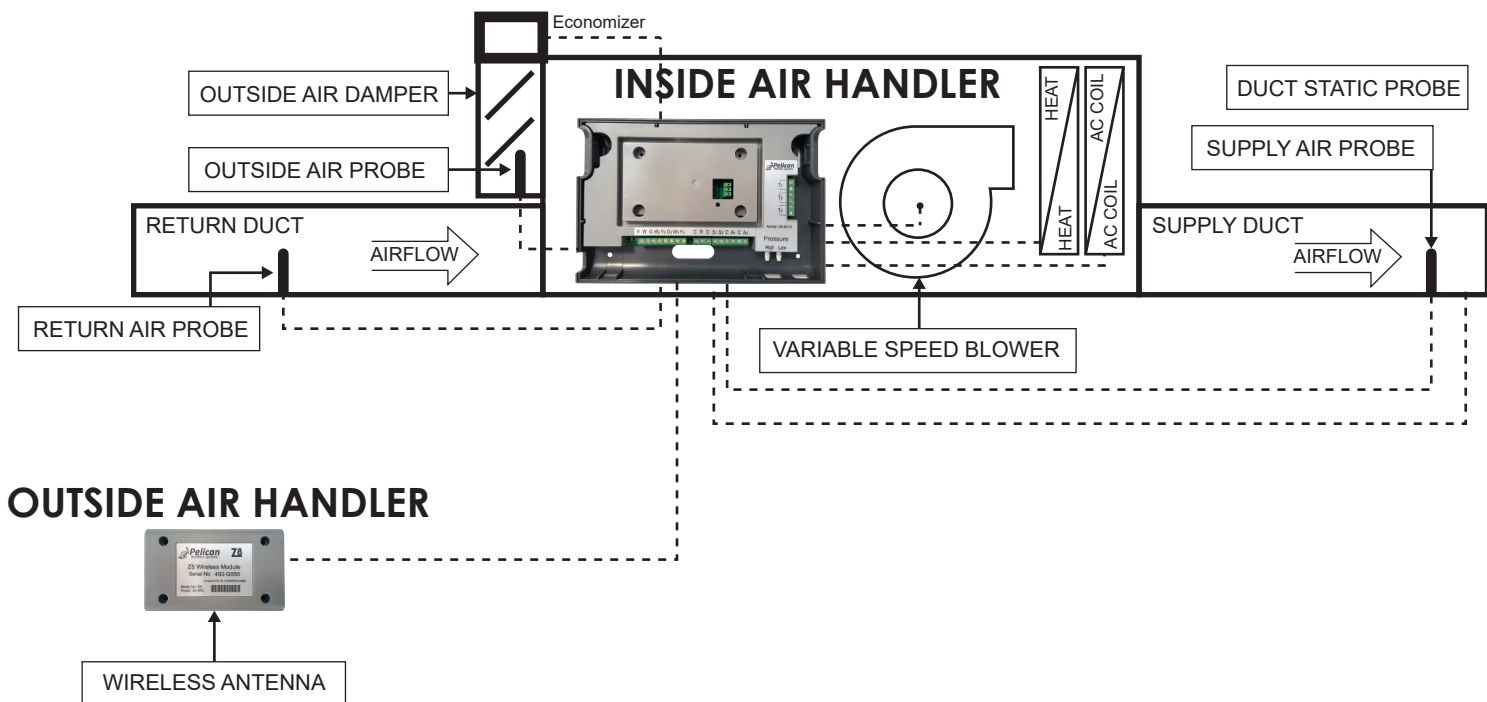
**Fig. 2 – Typical mounting at HVAC unit.**



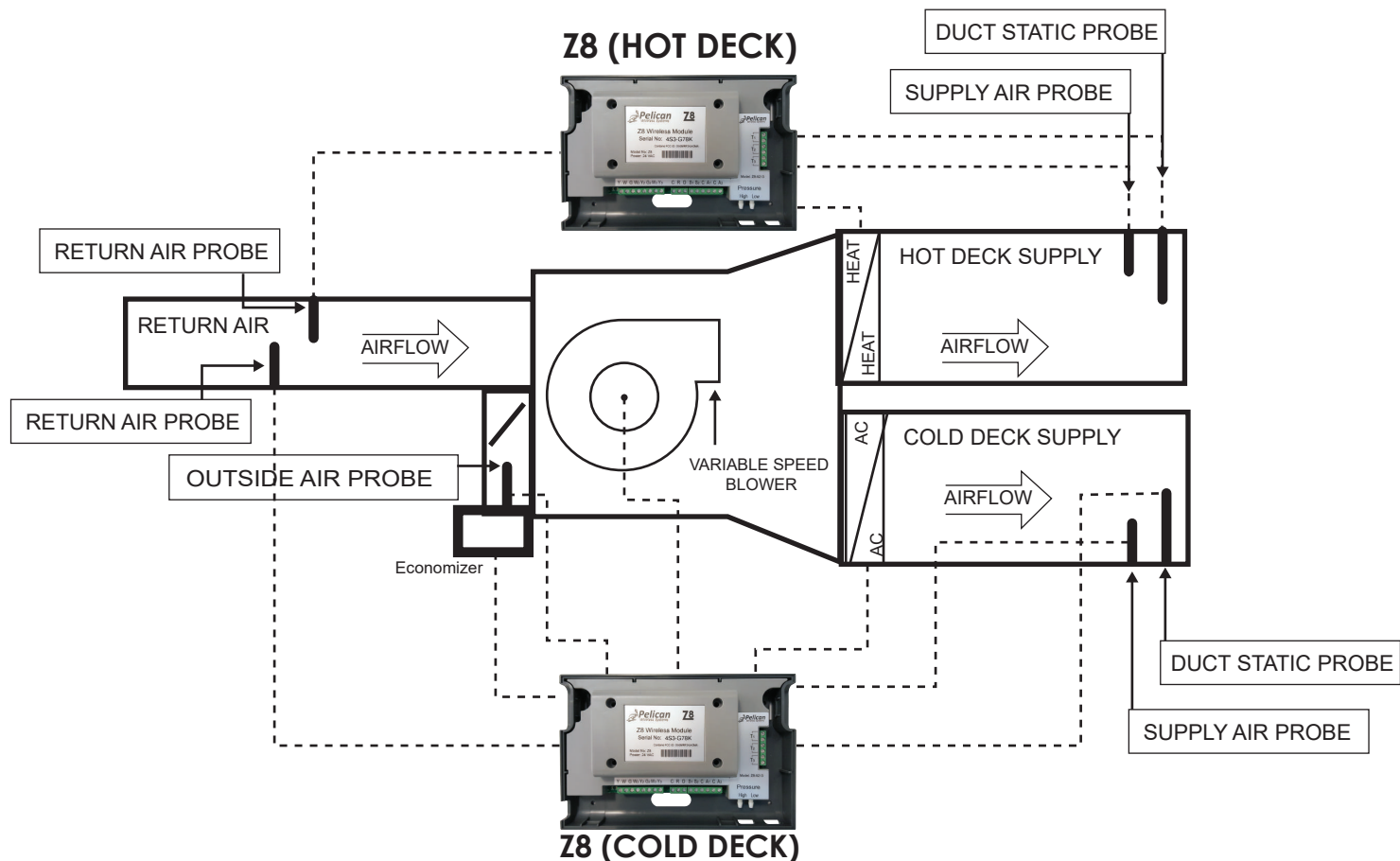
**Fig. 3 – Typical single duct system with bypass and economizer.**



**Fig. 4 – Typical mounting single duct system with VFD and economizer.**

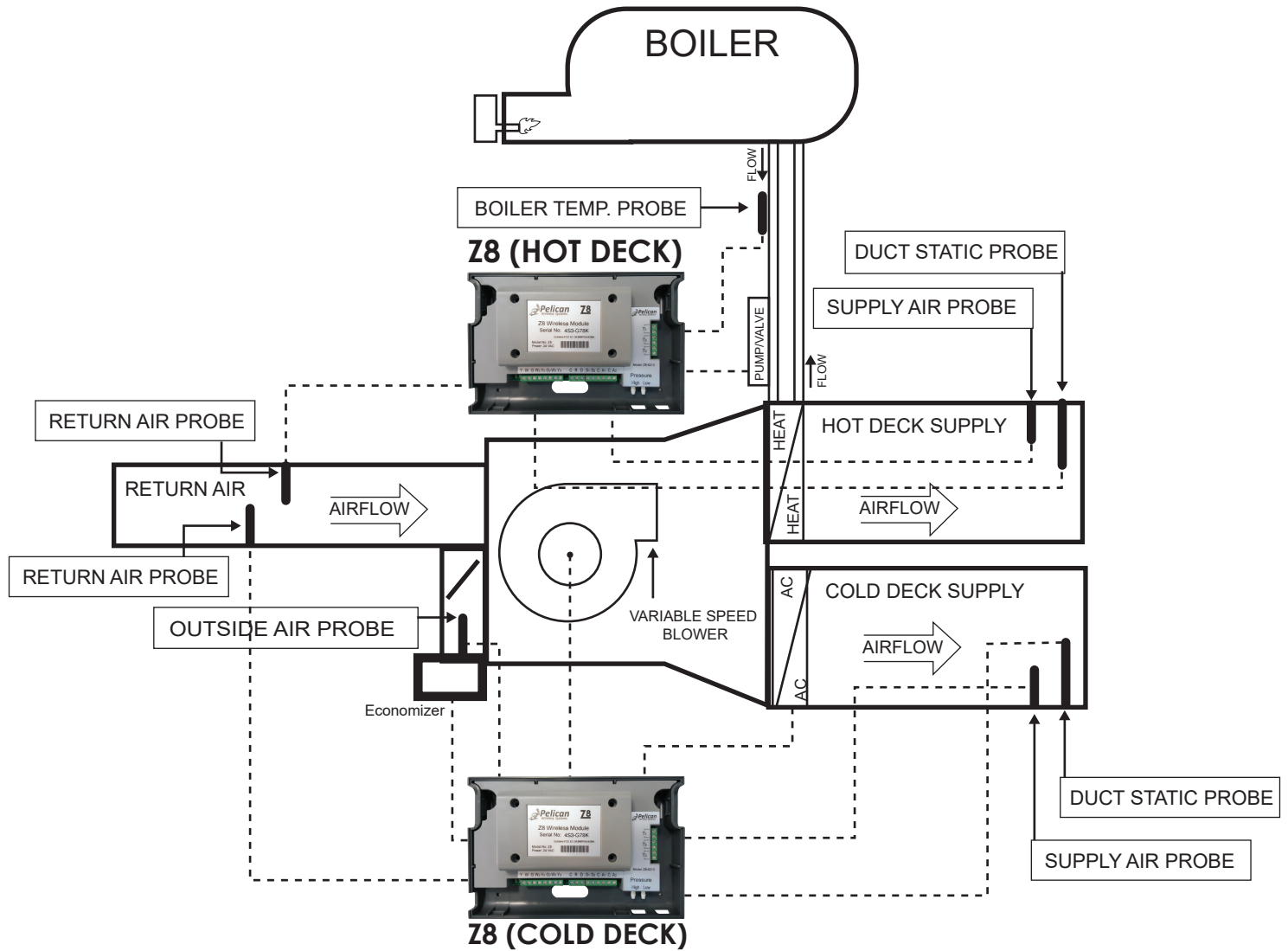


**Fig. 5 – Typical mounting dual duct system with VFD and economizer.**





**Fig. 6 – Typical mounting dual duct system with VFD, economizer, and boiler for hot deck.**



**CAUTION**

Always remove the Wireless Module if the Z8 is installed enclosed in metal (i.e.: inside the HVAC unit). The Wireless Module will not be able to communicate if metal is blocking its signal.



**WARNING**

If installing the Wireless Module outside, make sure it is installed onto a PLASTIC electrical box. Make sure a proper seal is created between the Wireless Module, the provided gasket, and the contact edge of the plastic electrical box.

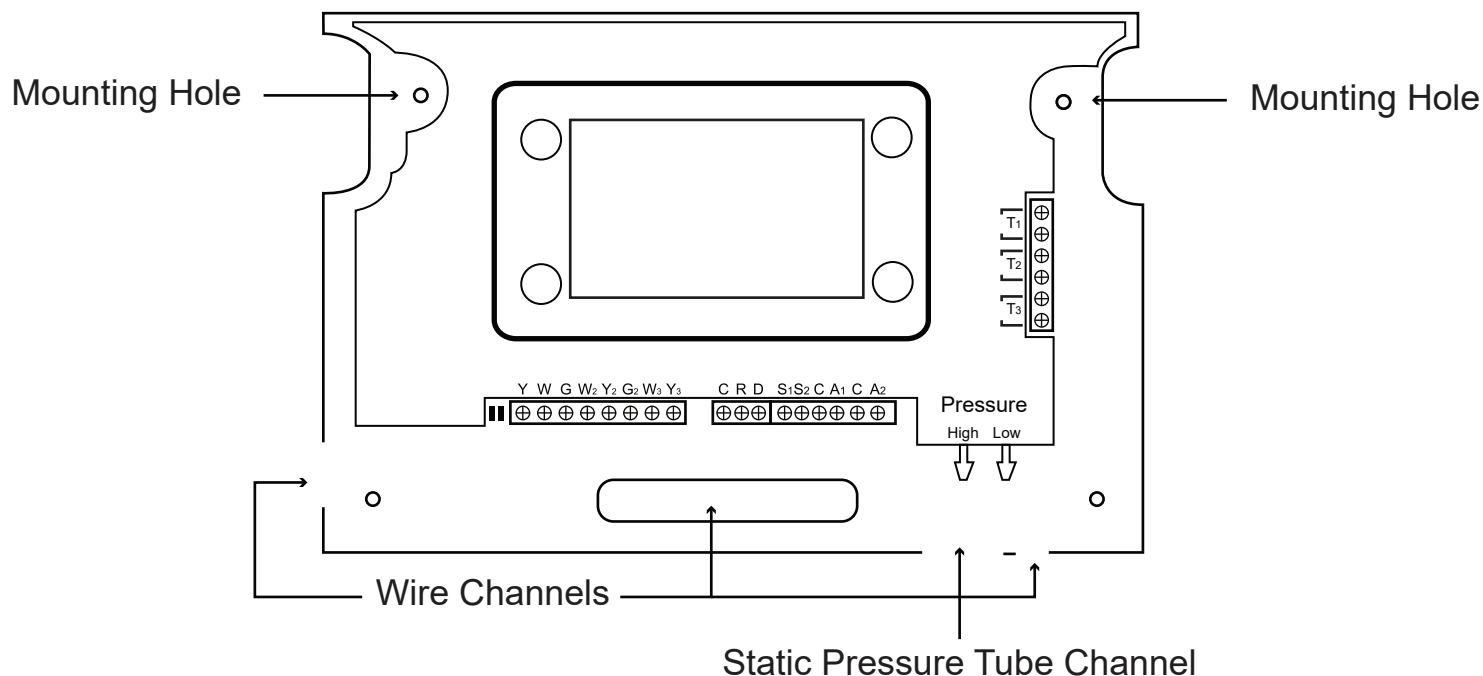
---

# INSTALLATION PROCESS

---

1. Remove the Z8 front cover by placing two fingers into indents along both sides of the controller. Front cover should pull away from back panel with a small amount of upward force. This will expose the terminal blocks, mounting holes, and wireless module.

2. Place the Z8 back plate on a flat surface for mounting. Mark mounting holes and drill 3/16" holes into mounting surface (Reference Page 12 Figure 7). Note the provided wiring channels. There is also a channel for the static pressure tubing.



3. If the Z8 is installed inside the HVAC unit or is enclosed in metal. The wireless module will need to be removed from the Z8 and installed either below the roof-line or outside the HVAC unit on a plastic weatherproof electrical box (Reference Pages 13 and 14 Figures 8 and 9). The Z8 Wiring Guides are layed out as follows:

- a. Fig. 8 shows wiring the Wireless Module to the Z8. (Page 13)
- b. Fig. 9 shows installing the Wireless Module on a plastic weatherproof electrical box. (Page 14)
- c. Fig. 10 shows the Z8 wired to a Conventional HVAC unit. (Page 15)
- d. Fig. 11 shows the Z8 wired to a Conventional HVAC unit with a Bypass. (Page 16)
- e. Fig. 12 shows the Z8 wired to a Conventional HVAC unit with a Bypass and Economizer. (Page 17)
- f. Fig. 13 shows the Z8 wired to a Conventional HVAC unit with a VFD. (Page 18)
- g. Fig. 14 shows the Z8 wired to a Conventional HVAC unit with a VFD and Economizer. (Page 19)
- h. Fig. 15 shows the Z8 wired to a Conventional HVAC unit with an Economizer. (Page 20)

- 
- i. Fig. 16 shows the Z8 wired to a Heat Pump HVAC unit. (Page 21)
  - j. Fig. 17 shows the Z8 wired to a Heat Pump HVAC unit with a Bypass. (Page 22)
  - k. Fig. 18 shows the Z8 wired to a Heat Pump HVAC unit with a Bypass and Economizer. (Page 23)
  - l. Fig. 19 shows the Z8 wired to a Heat Pump HVAC unit with a VFD. (Page 24)
  - m. Fig. 20 shows the Z8 wired to a Heat Pump HVAC unit with a VFD and Economizer. (Page 25)
  - n. Fig. 21 shows the Z8 wired to a Heat Pump HVAC unit with an Economizer. (Page 26)
  - o. Fig. 22 shows the Z8 wired to a Boiler. (Page 27)

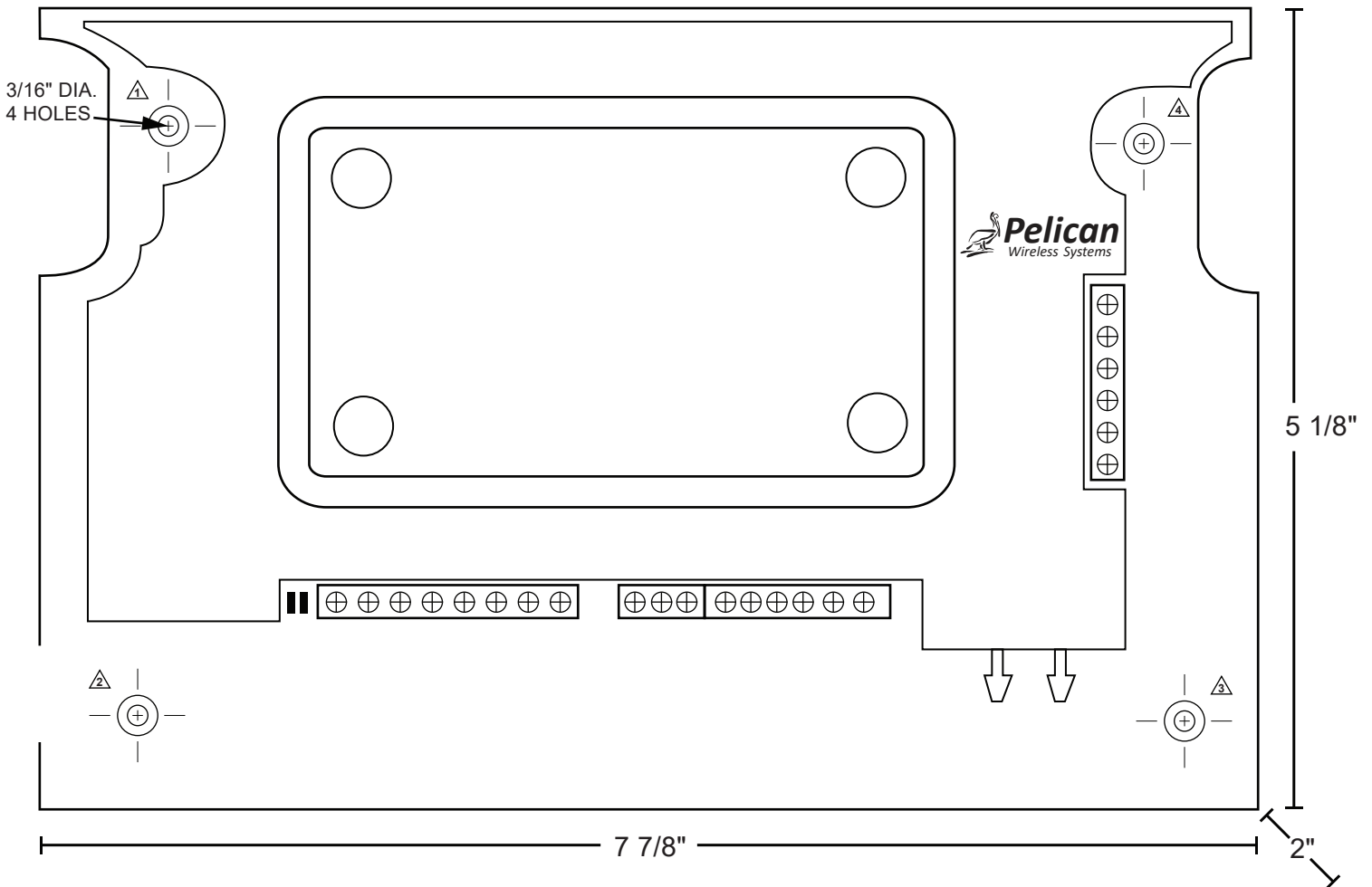
**4. Once the Z8 is installed and wired to the HVAC unit, follow the configuration sections starting on Page 28. The Z8 Configuration Sections shows configuration options for the Z8 as follows:**

- a. Step 1: Pelican Web App (Page 28)
- b. Step 2: Z8 Serial Number (Page 28)
- c. Step 3: System Configuration Options (Page 28)
- d. Step 4: Static Management Configuration Options (Page 29)
- e. Step 5: Economizer Configuration Options (Page 29)
- f. Step 6: Boiler Control Configuration Options (Page 30)
- g. Step 7: Input Sensors Configuration Options (Page 30)

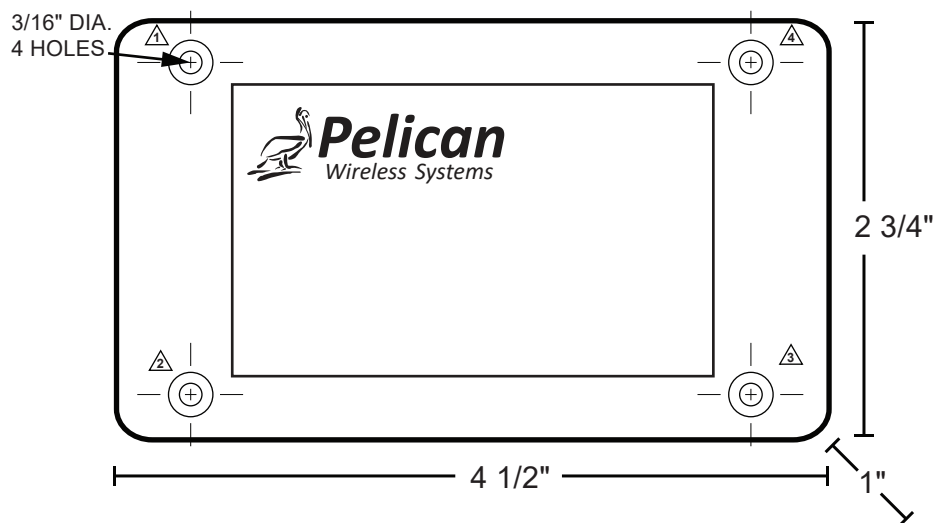
**5. Install the zone thermostats by following the *Zone Damper Installation Guide* (if not already completed) which was provided with the Z8.**

**6. Use the provided Check-Out and Verification Document provided with the Z8 to confirm proper operation of the equipment and the zoned solution.**

### Z8 mounting dimensions (inches).



### Wireless Module mounting dimensions (inches).



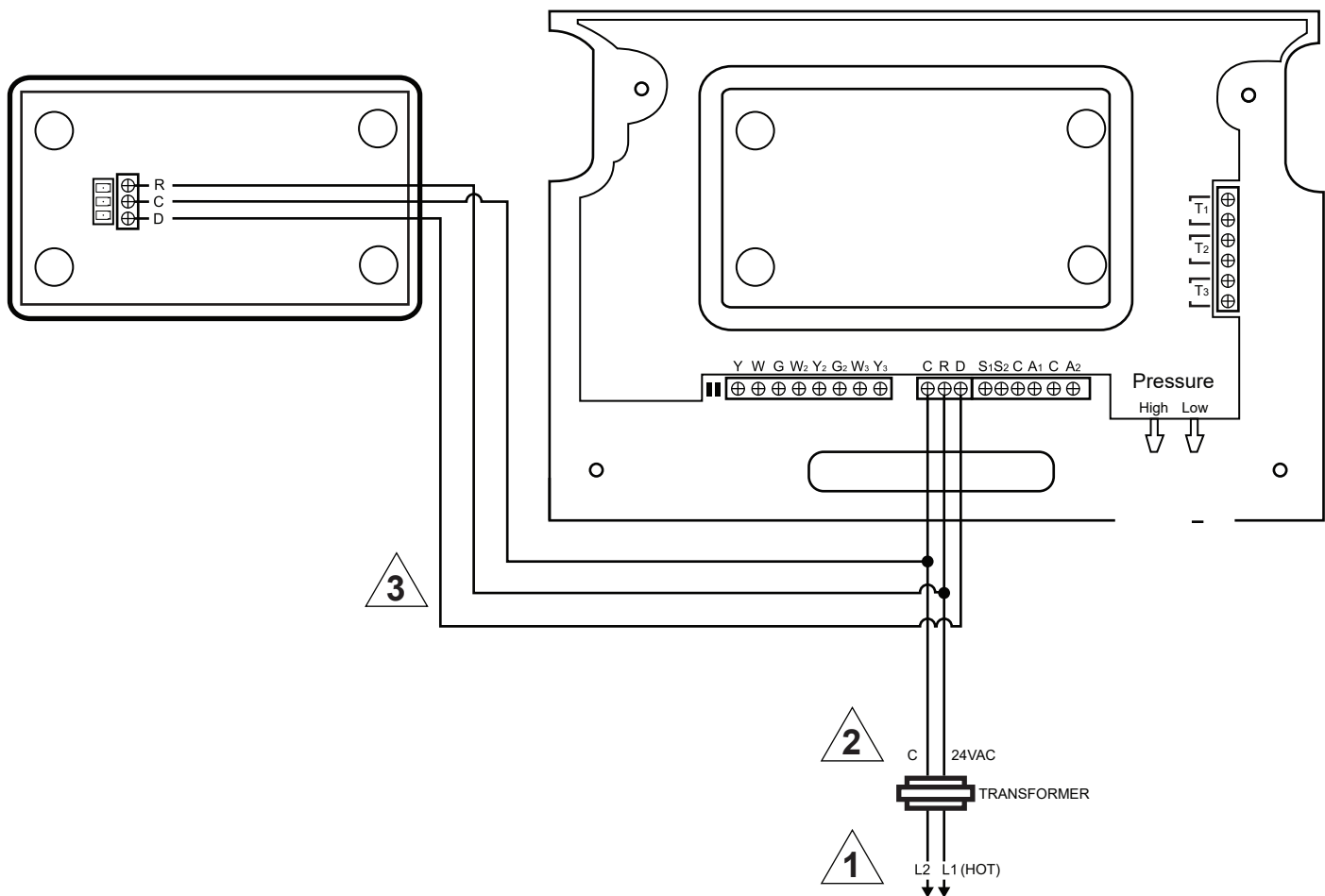
**Fig. 7**

## **! WARNING**

The following Operation and Application diagrams are to be used as reference to the most common application where the Z8 will be installed to control specific HVAC systems. For dual ducted applications, two Z8s will need to be installed. One for the hot deck and the other for the cold deck (reference Fig 4.3 and 4.4). In the case the system you are connecting the Z8 to is not defined in this installation guide. Contact Pelican Technical Support for assistance at 888-512-0490 or email [support@pelicanwireless.com](mailto:support@pelicanwireless.com).

## **Wiring the Z8 to the Wireless Module (if removed from Z8 base)**

**! NOTE:** TERMINAL DESIGNATIONS ARE DEFINED ON PAGE 5



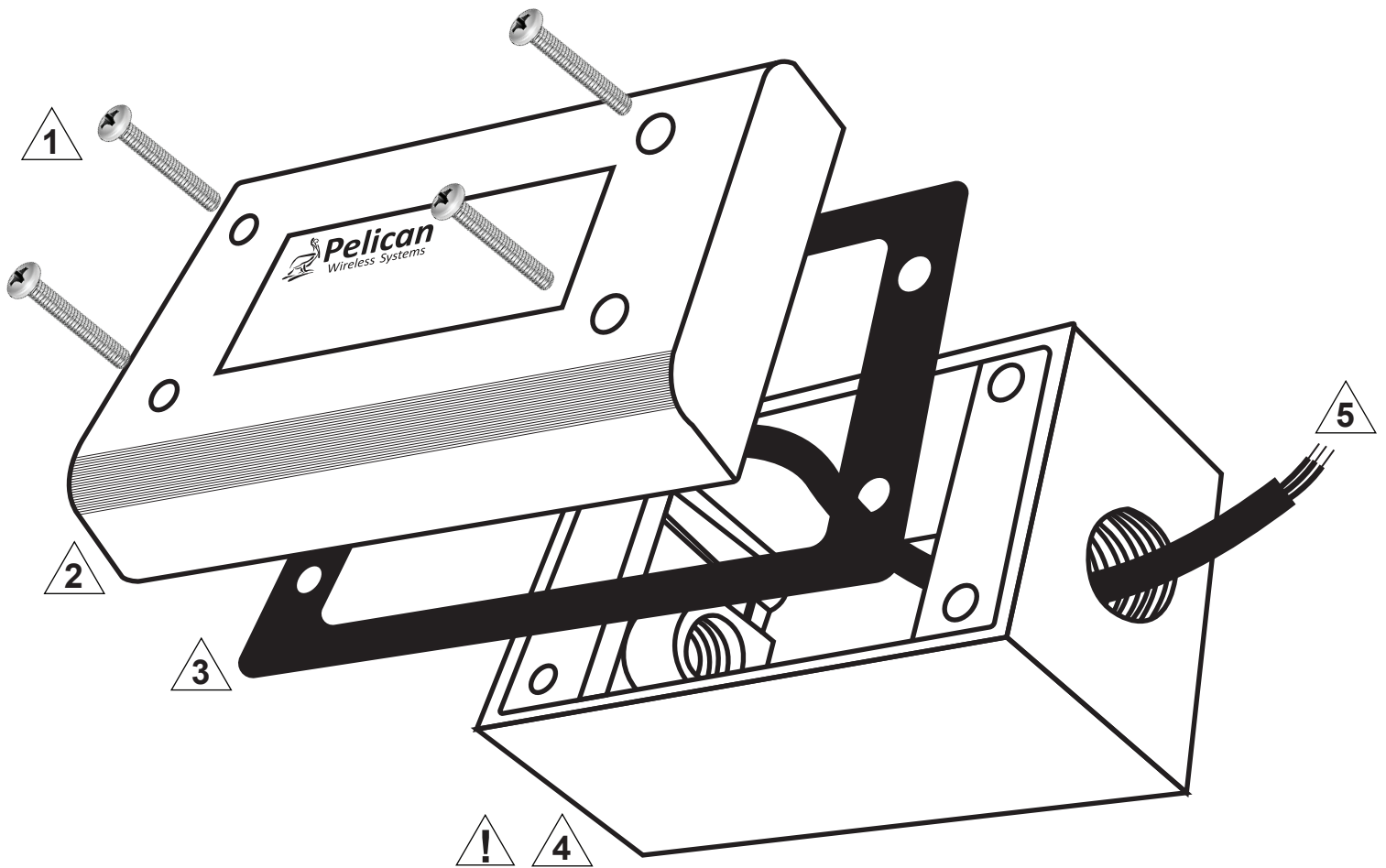
**1** POWER SUPPLY. PROVIDE DISCONNECT MEANS AND OVERLOAD PROTECTION AS REQUIRED.

**2** POWER TO Z8 AND WIRELESS MODULE IS 24VAC. SIZE TRANSFORMER AS NEEDED.

**3** WIRE CONNECTING THE WIRELESS MODULE TO THE Z8 CAN BE STANDARD UNSHIELDED COPPER THERMOSTAT WIRE UP TO 500 FEET.

**Fig. 8**

**Fig. 6 – (Optional ⚠ ) Installing Wireless Module on Plastic Outdoor Electrical Box Outside of HVAC unit.**



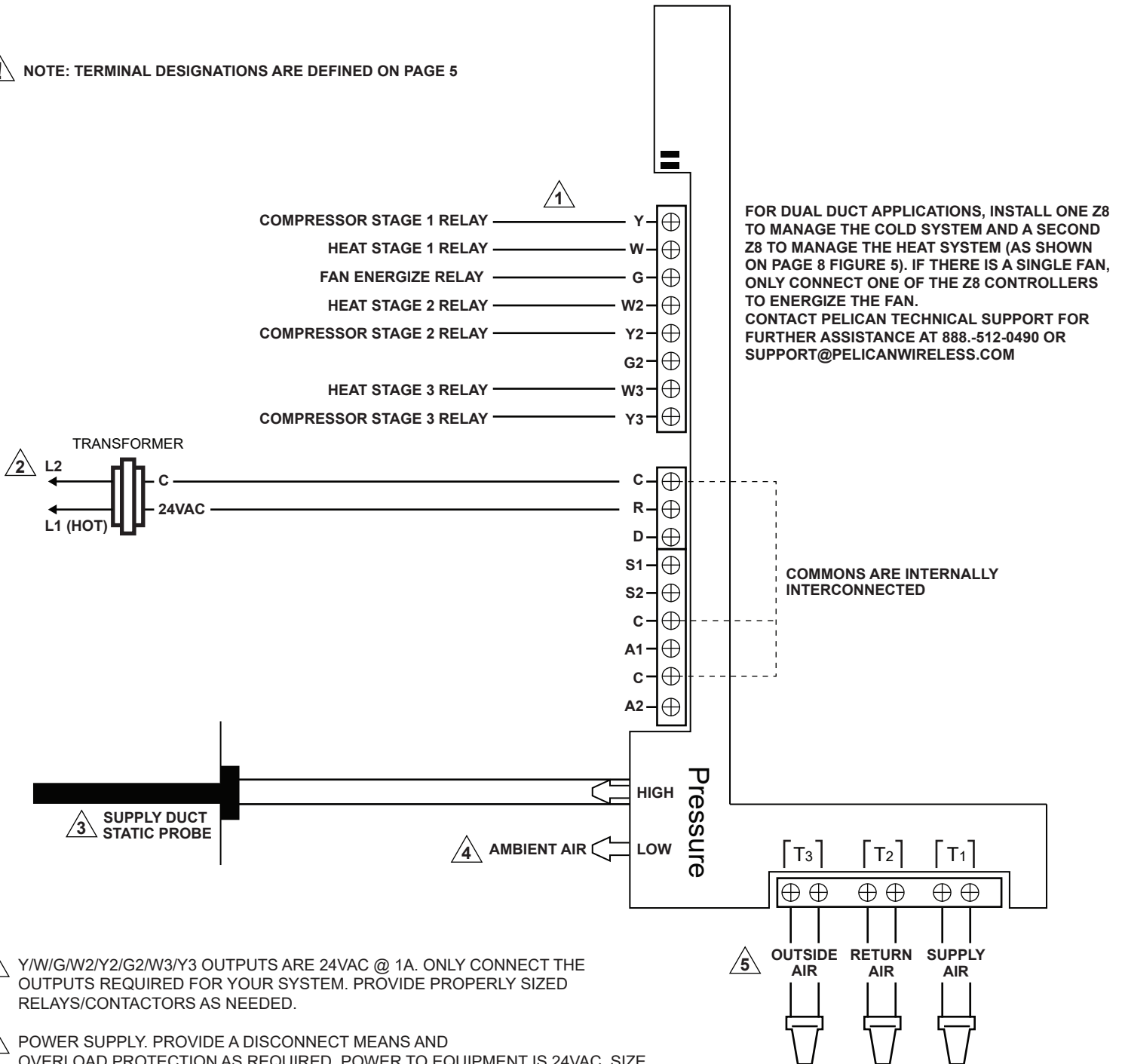
- 1 USE PROVIDED (4) 3/16" MACHINE SCREWS FOR MOUNTING WIRELESS MODULE ONTO RATED OUTDOOR ELECTRICAL BOX.
  - 2 WIRELESS MODULE IS MOUNTED HORIZONTALLY. DEVICE IS WATERPROOF WHEN PROPERLY INSTALLED WITH GASKET IN BETWEEN AN OUTDOOR RATED PLASTIC ELECTRICAL BOX. LOGO SHOULD BE LEGIBLE WHEN MOUNTED PROPERLY.
  - 3 MOUNT PROVIDED GASKET BETWEEN WIRELESS MODULE AND PLASTIC ELECTRICAL BOX. VERIFY THAT SEAL IS COMPLETE AROUND ENTIRE EDGE OF WIRELESS MODULE.
  - 4 ELECTRICAL BOX MUST BE PLASTIC AND PLACED OUTSIDE OF METAL ENCLOSURES. ELECTRICAL BOX MUST BE OUTDOOR RATED AND WEATHERPROOF.
  - 5 THREE WIRE BETWEEN WIRELESS MODULE AND Z8 CAN BE STANDARD UNSHIELDED COPPER THERMOSTAT WIRE UP TO 500 FEET (REF. PAGE 13 FIGURE 8).
- ⚠ NOTE: ELECTRICAL BOX IS NOT REQUIRED WHEN MOUNTING WIRELESS MODULE INSIDE OF THE BUILDING OR IF INSTALLED WHERE THE WIRELESS MODULE IS PROTECTED FROM THE WEATHER.

**Fig. 9**

# Conventional Wiring Guide

The following wiring diagram is for a conventional system

**NOTE:** TERMINAL DESIGNATIONS ARE DEFINED ON PAGE 5



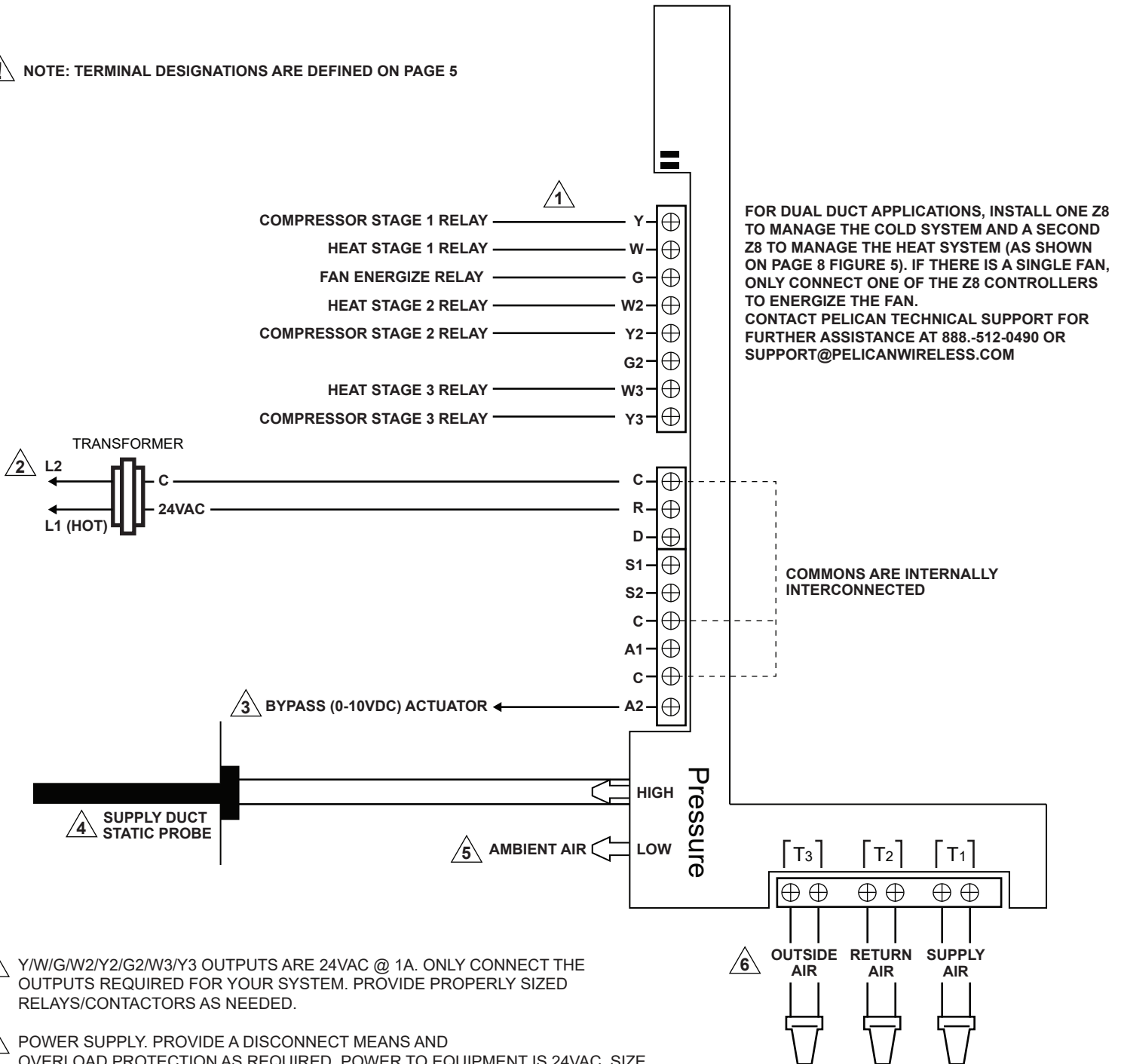
- 1** Y/W/G/W2/Y2/G2/W3/Y3 OUTPUTS ARE 24VAC @ 1A. ONLY CONNECT THE OUTPUTS REQUIRED FOR YOUR SYSTEM. PROVIDE PROPERLY SIZED RELAYS/CONTACTORS AS NEEDED.
- 2** POWER SUPPLY. PROVIDE A DISCONNECT MEANS AND OVERLOAD PROTECTION AS REQUIRED. POWER TO EQUIPMENT IS 24VAC. SIZE TRANSFORMERS AS NEEDED.
- 3** INSTALL STATIC PROBE IN SUPPLY/DISCHARGE AIR DUCT. RECOMMEND INSTALLATION OF AT LEAST SIX (6) FEET AWAY FROM FAN OR ANY BENDS IN DUCT WORK.
- 4** USED FOR AMBIENT AIR PRESSURE SENSING. SOME APPLICATIONS MAY REQUIRE RUNNING ADDITIONAL TUBING TO THE OUTSIDE OF HVAC UNIT.
- 5** T1/T2/T3 ARE 10K TYPE 2 TEMPERATURE PROBE INPUTS. SUPPLY AND RETURN AIR TEMPERATURE PROBES ARE MANDATORY FOR PROPER OPERATION.

**Fig. 10**

# Bypass Wiring Guide (Conventional)

The following wiring diagram is for a conventional system with a bypass.

**NOTE:** TERMINAL DESIGNATIONS ARE DEFINED ON PAGE 5



- 1** Y/W/G/W2/Y2/G2/W3/Y3 OUTPUTS ARE 24VAC @ 1A. ONLY CONNECT THE OUTPUTS REQUIRED FOR YOUR SYSTEM. PROVIDE PROPERLY SIZED RELAYS/CONTACTORS AS NEEDED.
- 2** POWER SUPPLY. PROVIDE A DISCONNECT MEANS AND OVERLOAD PROTECTION AS REQUIRED. POWER TO EQUIPMENT IS 24VAC. SIZE TRANSFORMERS AS NEEDED.
- 3** A2 IS A 0-10VDC OUTPUT FOR MODULATING THE BYPASS ACTUATOR.
- 4** INSTALL STATIC PROBE IN SUPPLY/DISCHARGE AIR DUCT. RECOMMEND INSTALLATION OF AT LEAST SIX (6) FEET AWAY FROM FAN OR ANY BENDS IN DUCT WORK.
- 5** USED FOR AMBIENT AIR PRESSURE SENSING. SOME APPLICATIONS MAY REQUIRE RUNNING ADDITIONAL TUBING TO THE OUTSIDE OF HVAC UNIT.
- 6** T1/T2/T3 ARE 10K TYPE 2 TEMPERATURE PROBE INPUTS. SUPPLY AND RETURN AIR TEMPERATURE PROBES ARE MANDATORY FOR PROPER OPERATION.

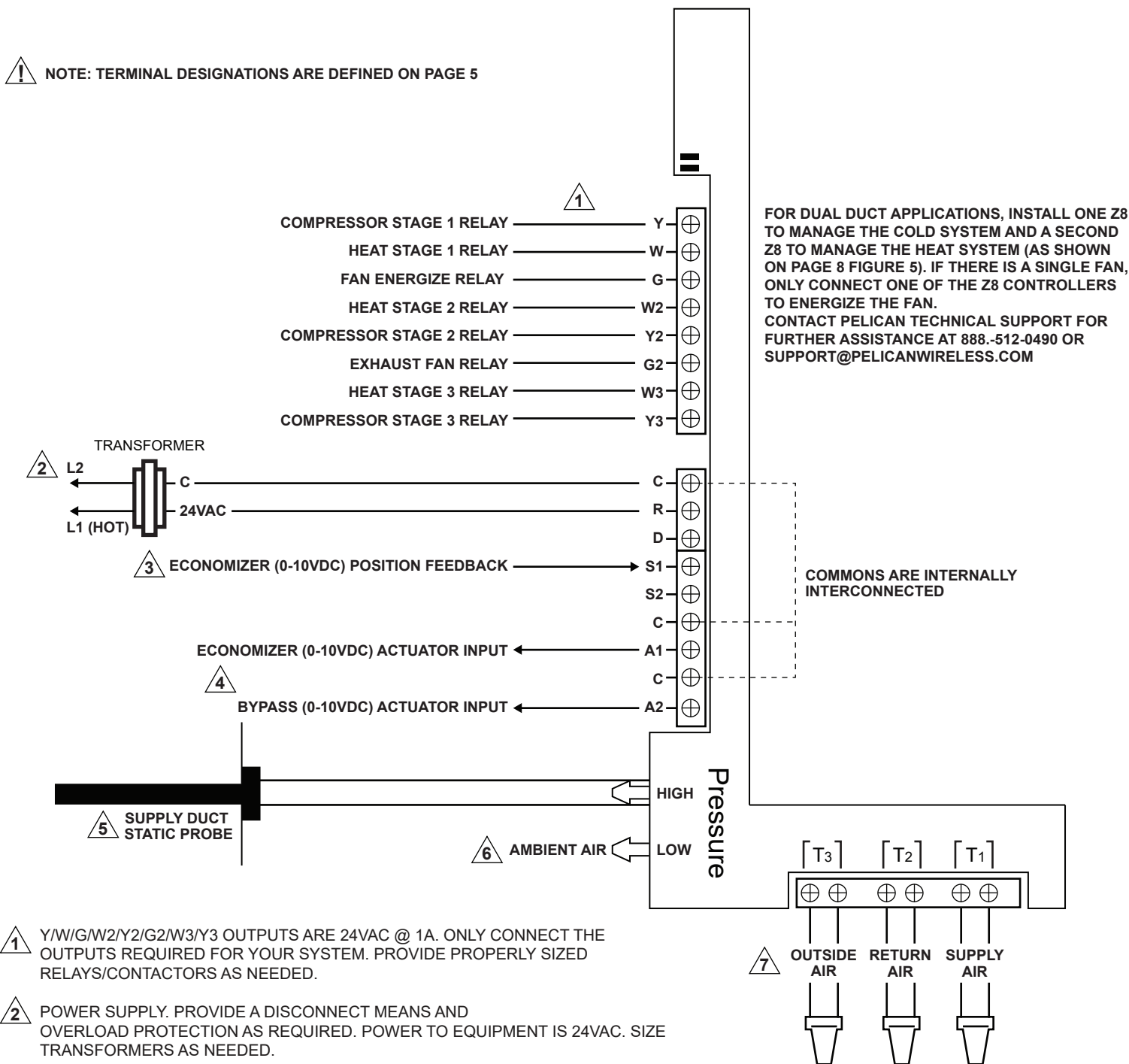
**Fig. 11**



# Bypass And Economizer Wiring Guide (Conventional)

The following wiring diagram is for a conventional system with a bypass and economizer.

**!** NOTE: TERMINAL DESIGNATIONS ARE DEFINED ON PAGE 5



**1** Y/W/G/W2/Y2/G2/W3/Y3 OUTPUTS ARE 24VAC @ 1A. ONLY CONNECT THE OUTPUTS REQUIRED FOR YOUR SYSTEM. PROVIDE PROPERLY SIZED RELAYS/CONTACTORS AS NEEDED.

**2** POWER SUPPLY. PROVIDE A DISCONNECT MEANS AND OVERLOAD PROTECTION AS REQUIRED. POWER TO EQUIPMENT IS 24VAC. SIZE TRANSFORMERS AS NEEDED.

**3** S1 IS A 0-10VDC INPUT FOR ECONOMIZER ACTUATOR POSITION FEEDBACK FAULT DETECTION AND DIAGNOSTICS.

**4** A1 IS A 0-10VDC OUTPUT FOR MODULATING THE ECONOMIZER ACTUATOR. A2 IS A 0-10VDC OUTPUT FOR MODULATING THE BYPASS ACTUATOR.

**5** INSTALL STATIC PROBE IN SUPPLY/DISCHARGE AIR DUCT. RECOMMEND INSTALLATION OF AT LEAST SIX (6) FEET AWAY FROM FAN OR ANY BENDS IN DUCT WORK.

**6** USED FOR AMBIENT AIR PRESSURE SENSING. SOME APPLICATIONS MAY REQUIRE RUNNING ADDITIONAL TUBING TO THE OUTSIDE OF HVAC UNIT.

**7** T1/T2/T3 ARE 10K TYPE 2 TEMPERATURE PROBE INPUTS. SUPPLY AND RETURN AIR TEMPERATURE PROBES ARE MANDATORY FOR PROPER OPERATION.

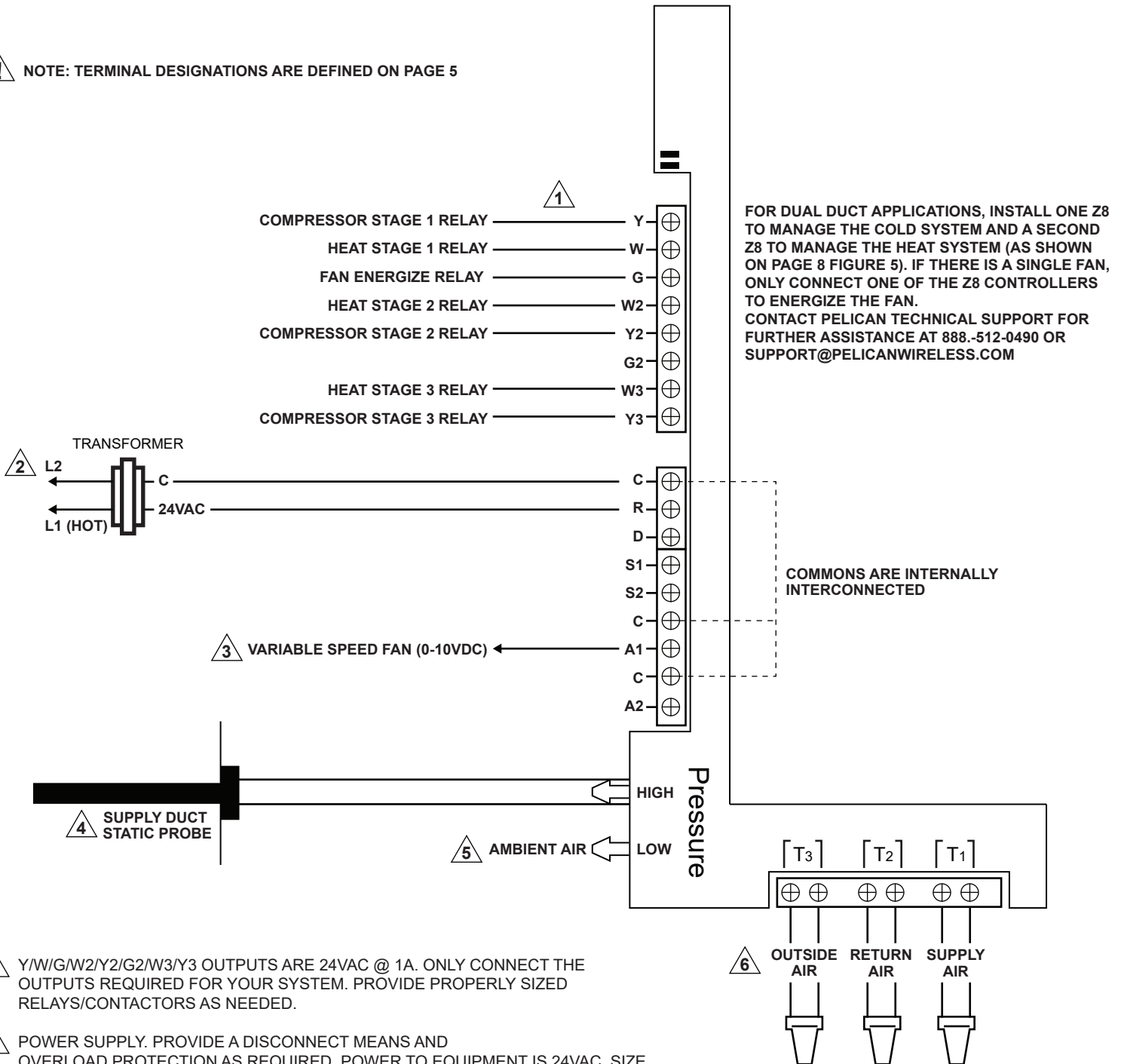
**(G2)** IF AN EXHAUST FAN IS INSTALLED AND NEEDS TO BE ENERGIZED DURING ECONOMIZATION, CONNECT THE (G2) 24VAC OUTPUT TO THE EXHAUST FAN. PROVIDE PROPERLY SIZED RELAY/CONTACTORS AS NEEDED.

**Fig. 12**

# Variable Speed Fan Wiring Guide (Conventional)

The following wiring diagram is for a conventional system with a variable speed fan (VFD).

**⚠ NOTE: TERMINAL DESIGNATIONS ARE DEFINED ON PAGE 5**



- 1** Y/W/G/W2/Y2/G2/W3/Y3 OUTPUTS ARE 24VAC @ 1A. ONLY CONNECT THE OUTPUTS REQUIRED FOR YOUR SYSTEM. PROVIDE PROPERLY SIZED RELAYS/CONTACTORS AS NEEDED.
- 2** POWER SUPPLY. PROVIDE A DISCONNECT MEANS AND OVERLOAD PROTECTION AS REQUIRED. POWER TO EQUIPMENT IS 24VAC. SIZE TRANSFORMERS AS NEEDED.
- 3** A1 IS A 0-10VDC OUTPUT FOR MODULATING THE FAN SPEED.
- 4** INSTALL STATIC PROBE IN SUPPLY/DISCHARGE AIR DUCT. RECOMMEND INSTALLATION OF AT LEAST SIX (6) FEET AWAY FROM FAN OR ANY BENDS IN DUCT WORK.
- 5** USED FOR AMBIENT AIR PRESSURE SENSING. SOME APPLICATIONS MAY REQUIRE RUNNING ADDITIONAL TUBING TO THE OUTSIDE OF HVAC UNIT.
- 6** T1/T2/T3 ARE 10K TYPE 2 TEMPERATURE PROBE INPUTS. SUPPLY AND RETURN AIR TEMPERATURE PROBES ARE MANDATORY FOR PROPER OPERATION.

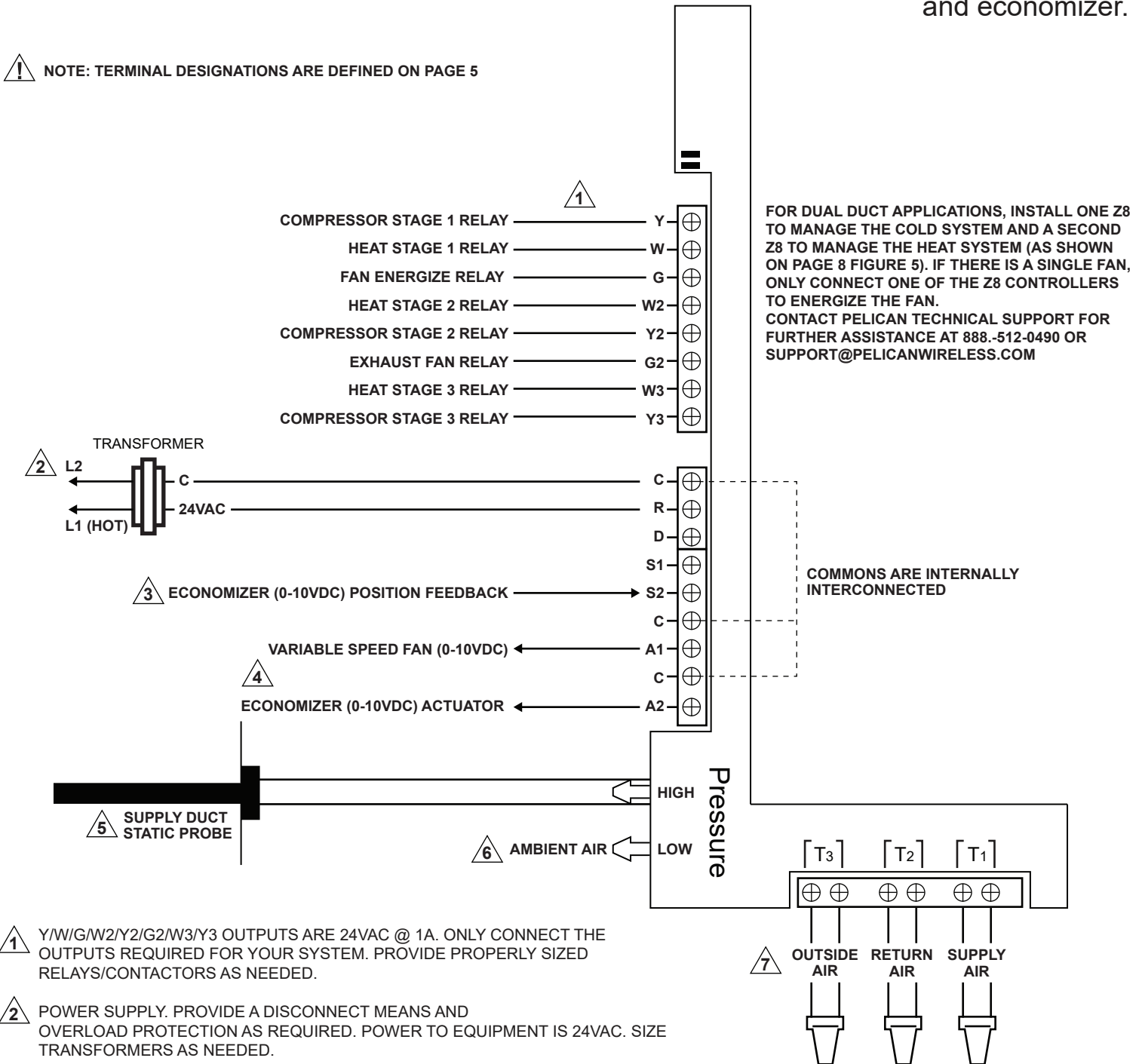
**G** USE THE (G) 24VAC OUTPUT TO ENERGIZE THE FAN. PROVIDE PROPERLY SIZED RELAY/CONTACTORS AS NEEDED.

**Fig. 13**

# Variable Speed Fan and Economizer Wiring Guide (Conventional)

The following wiring diagram is for a conventional system with a variable speed fan (VFD) and economizer.

**NOTE:** TERMINAL DESIGNATIONS ARE DEFINED ON PAGE 5



**1** Y/W/G/W2/Y2/G2/W3/Y3 OUTPUTS ARE 24VAC @ 1A. ONLY CONNECT THE OUTPUTS REQUIRED FOR YOUR SYSTEM. PROVIDE PROPERLY SIZED RELAYS/CONTACTORS AS NEEDED.

**2** POWER SUPPLY. PROVIDE A DISCONNECT MEANS AND OVERLOAD PROTECTION AS REQUIRED. POWER TO EQUIPMENT IS 24VAC. SIZE TRANSFORMERS AS NEEDED.

**3** S2 IS A 0-10VDC INPUT FOR ECONOMIZER ACTUATOR POSITION FEEDBACK FAULT DETECTION AND DIAGNOSTICS.

**4** A1 IS A 0-10VDC OUTPUT FOR MODULATING THE FAN SPEED. A2 IS A 0-10VDC OUTPUT FOR MODULATING THE ECONOMIZER ACTUATOR.

**5** INSTALL STATIC PROBE IN SUPPLY/DISCHARGE AIR DUCT. RECOMMEND INSTALLATION OF AT LEAST SIX (6) FEET AWAY FROM FAN OR ANY BENDS IN DUCT WORK.

**6** USED FOR AMBIENT AIR PRESSURE SENSING. SOME APPLICATIONS MAY REQUIRE RUNNING ADDITIONAL TUBING TO THE OUTSIDE OF HVAC UNIT.

**7** T1/T2/T3 ARE 10K TYPE 2 TEMPERATURE PROBE INPUTS. SUPPLY AND RETURN AIR TEMPERATURE PROBES ARE MANDATORY FOR PROPER OPERATION.

**G** USE THE (G) 24VAC OUTPUT TO ENERGIZE THE FAN. PROVIDE PROPERLY SIZED RELAY/CONTACTORS AS NEEDED.

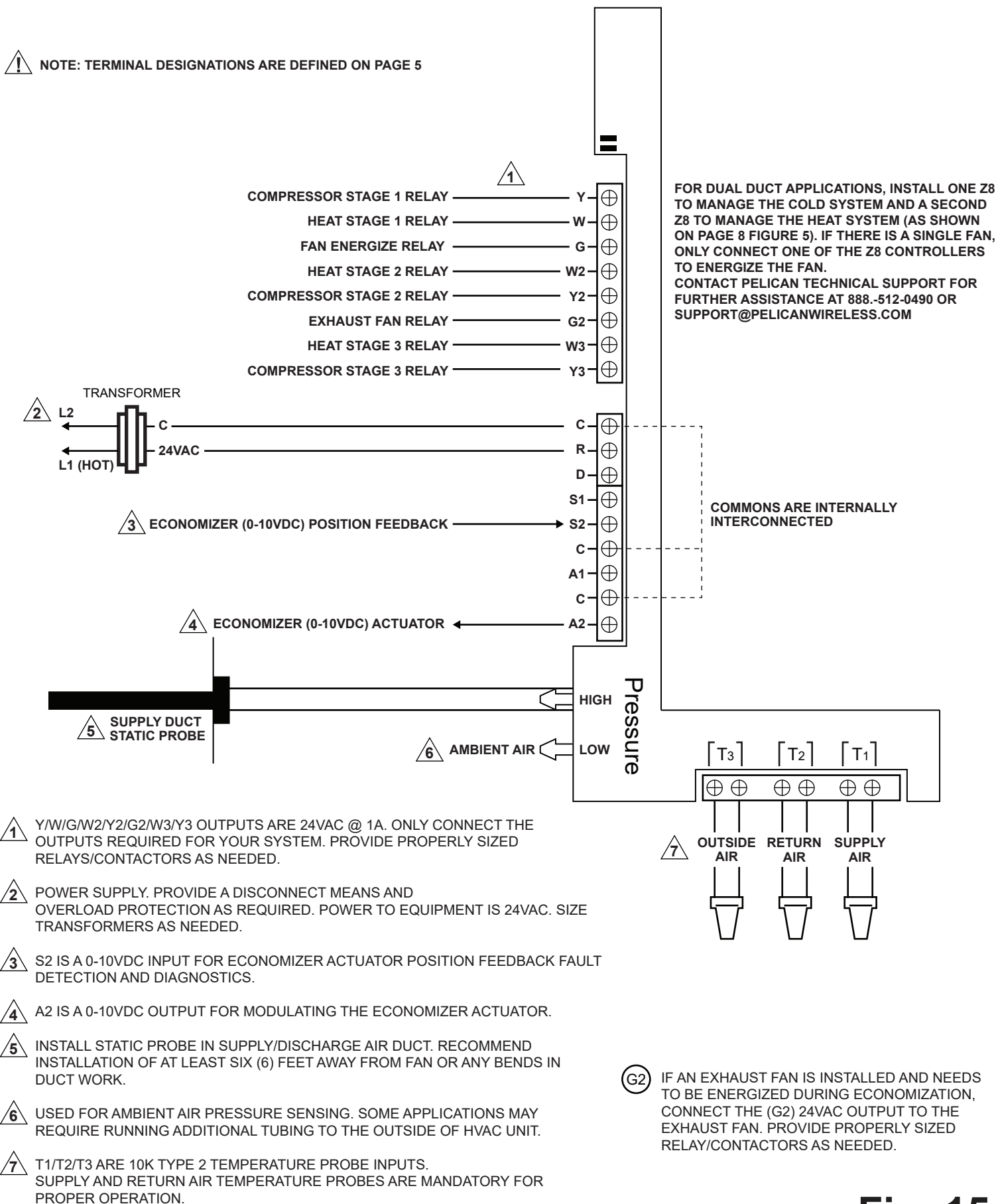
**G2** IF AN EXHAUST FAN IS INSTALLED AND NEEDS TO BE ENERGIZED DURING ECONOMIZATION, CONNECT THE (G2) 24VAC OUTPUT TO THE EXHAUST FAN. PROVIDE PROPERLY SIZED RELAY/CONTACTORS AS NEEDED.

**Fig. 14**

# Economizer Wiring Guide (Conventional)

The following wiring diagram is for a conventional system with an economizer.

**NOTE:** TERMINAL DESIGNATIONS ARE DEFINED ON PAGE 5

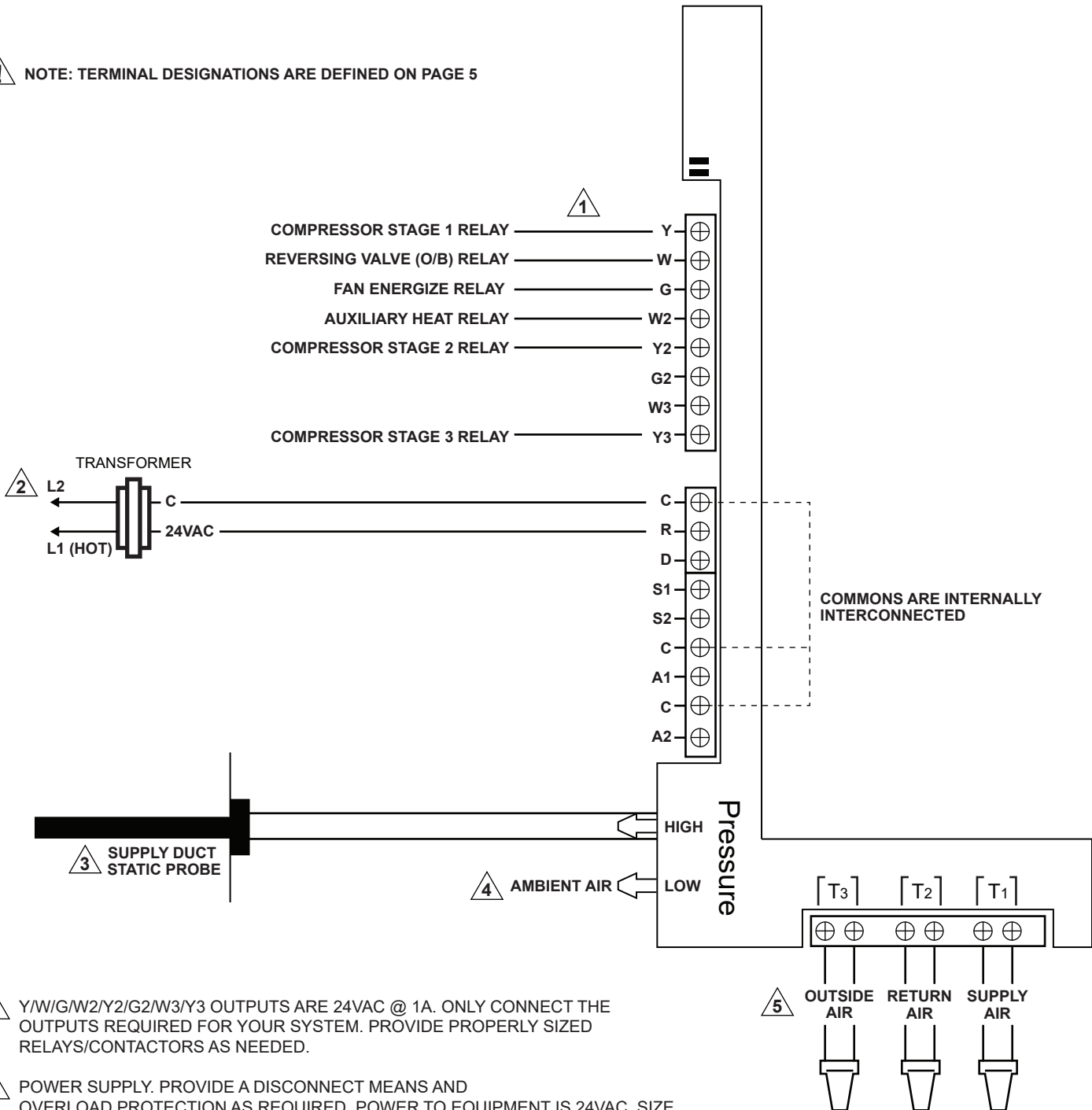


**Fig. 15**

# Heat Pump Wiring Guide

The following wiring diagram is for heat pump control

**NOTE: TERMINAL DESIGNATIONS ARE DEFINED ON PAGE 5**



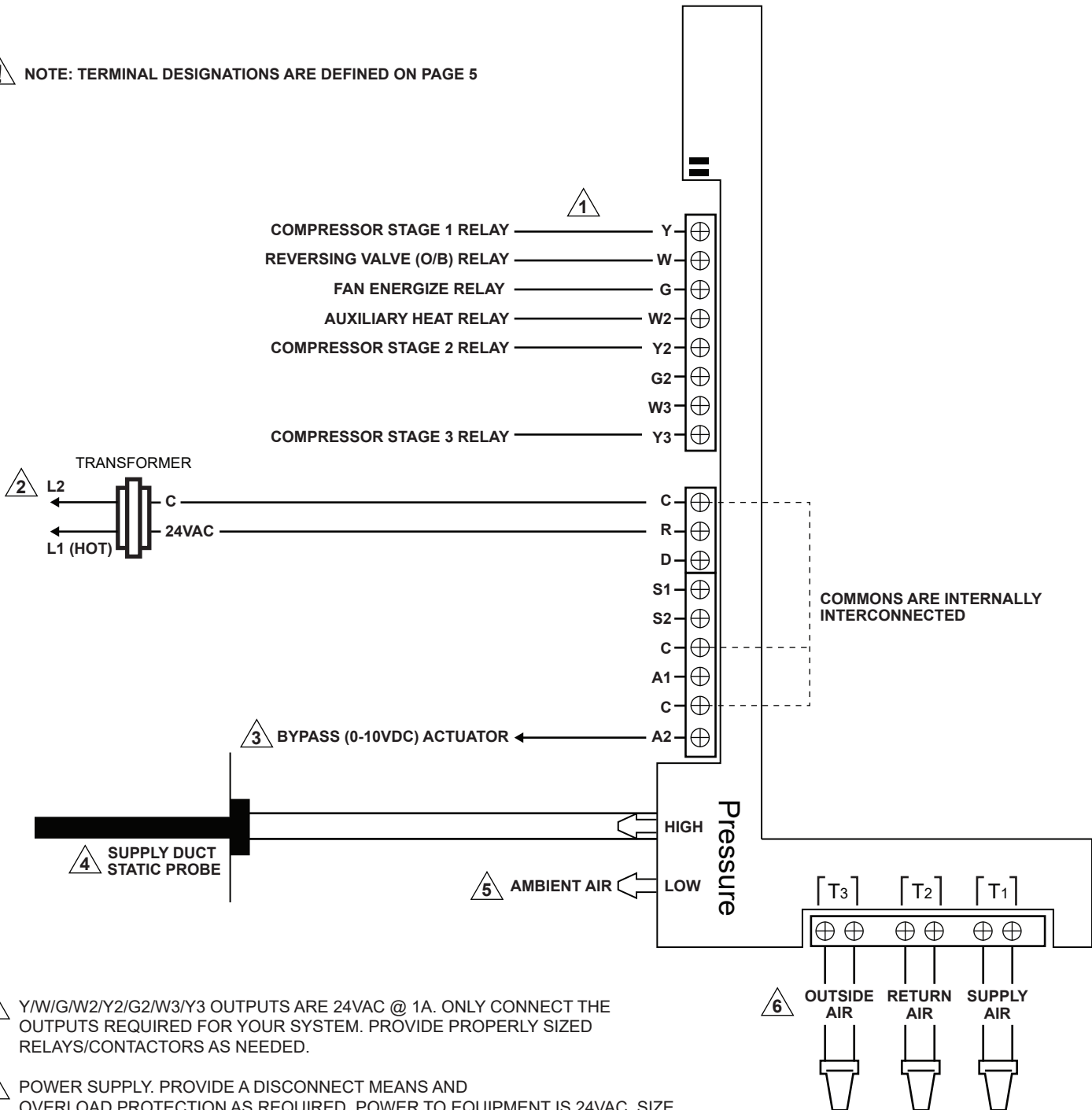
- 1** Y/W/G/W2/Y2/G2/W3/Y3 OUTPUTS ARE 24VAC @ 1A. ONLY CONNECT THE OUTPUTS REQUIRED FOR YOUR SYSTEM. PROVIDE PROPERLY SIZED RELAYS/CONTACTORS AS NEEDED.
- 2** POWER SUPPLY. PROVIDE A DISCONNECT MEANS AND OVERLOAD PROTECTION AS REQUIRED. POWER TO EQUIPMENT IS 24VAC. SIZE TRANSFORMERS AS NEEDED.
- 3** INSTALL STATIC PROBE IN SUPPLY/DISCHARGE AIR DUCT. RECOMMEND INSTALLATION OF AT LEAST SIX (6) FEET AWAY FROM FAN OR ANY BENDS IN DUCT WORK.
- 4** USED FOR AMBIENT AIR PRESSURE SENSING. SOME APPLICATIONS MAY REQUIRE RUNNING ADDITIONAL TUBING TO THE OUTSIDE OF HVAC UNIT.
- 5** T1/T2/T3 ARE 10K TYPE 2 TEMPERATURE PROBE INPUTS. SUPPLY AND RETURN AIR TEMPERATURE PROBES ARE MANDATORY FOR PROPER OPERATION.

**Fig. 16**

# Bypass Wiring Guide (Heat Pump)

The following wiring diagram is for a heat pump with a bypass.

**NOTE:** TERMINAL DESIGNATIONS ARE DEFINED ON PAGE 5



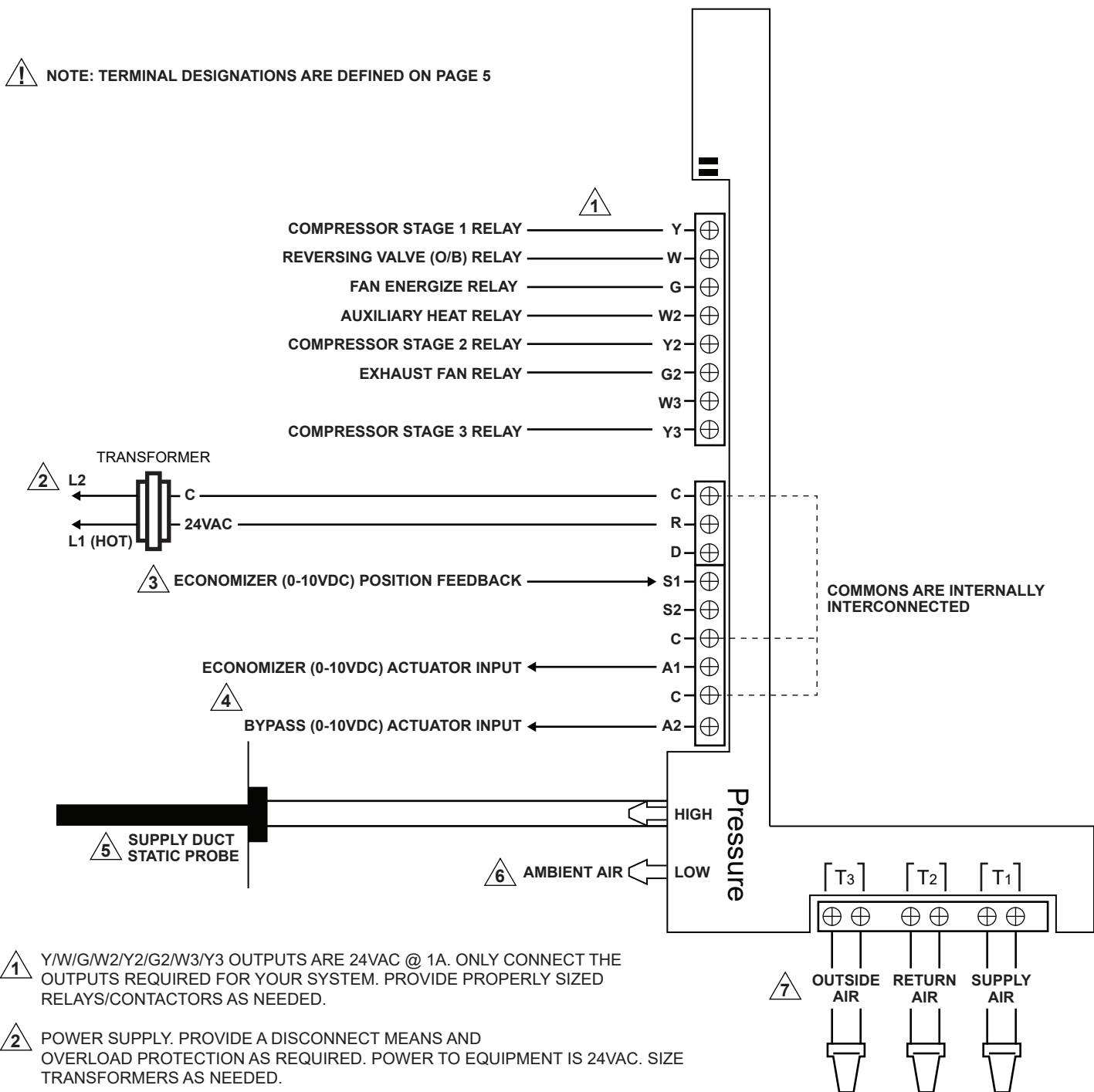
- 1 Y/W/G/W2/Y2/G2/W3/Y3 OUTPUTS ARE 24VAC @ 1A. ONLY CONNECT THE OUTPUTS REQUIRED FOR YOUR SYSTEM. PROVIDE PROPERLY SIZED RELAYS/CONTACTORS AS NEEDED.
- 2 POWER SUPPLY. PROVIDE A DISCONNECT MEANS AND OVERLOAD PROTECTION AS REQUIRED. POWER TO EQUIPMENT IS 24VAC. SIZE TRANSFORMERS AS NEEDED.
- 3 A2 IS A 0-10VDC OUTPUT FOR MODULATING THE BYPASS ACTUATOR.
- 4 INSTALL STATIC PROBE IN SUPPLY/DISCHARGE AIR DUCT. RECOMMEND INSTALLATION OF AT LEAST SIX (6) FEET AWAY FROM FAN OR ANY BENDS IN DUCT WORK.
- 5 USED FOR AMBIENT AIR PRESSURE SENSING. SOME APPLICATIONS MAY REQUIRE RUNNING ADDITIONAL TUBING TO THE OUTSIDE OF HVAC UNIT.
- 6 T1/T2/T3 ARE 10K TYPE 2 TEMPERATURE PROBE INPUTS. SUPPLY AND RETURN AIR TEMPERATURE PROBES ARE MANDATORY FOR PROPER OPERATION.

**Fig. 17**

# Bypass and Economizer Wiring Guide (Heat Pump)

The following wiring diagram is for a heat pump with a bypass and economizer.

**NOTE:** TERMINAL DESIGNATIONS ARE DEFINED ON PAGE 5



**1** Y/W/G/W2/Y2/G2/W3/Y3 OUTPUTS ARE 24VAC @ 1A. ONLY CONNECT THE OUTPUTS REQUIRED FOR YOUR SYSTEM. PROVIDE PROPERLY SIZED RELAYS/CONTACTORS AS NEEDED.

**2** POWER SUPPLY. PROVIDE A DISCONNECT MEANS AND OVERLOAD PROTECTION AS REQUIRED. POWER TO EQUIPMENT IS 24VAC. SIZE TRANSFORMERS AS NEEDED.

**3** S1 IS A 0-10VDC INPUT FOR ECONOMIZER ACTUATOR POSITION FEEDBACK FAULT DETECTION AND DIAGNOSTICS.

**4** A1 IS A 0-10VDC OUTPUT FOR MODULATING THE ECONOMIZER ACTUATOR. A2 IS A 0-10VDC OUTPUT FOR MODULATING THE BYPASS ACTUATOR.

**5** INSTALL STATIC PROBE IN SUPPLY/DISCHARGE AIR DUCT. RECOMMEND INSTALLATION OF AT LEAST SIX (6) FEET AWAY FROM FAN OR ANY BENDS IN DUCT WORK.

**6** USED FOR AMBIENT AIR PRESSURE SENSING. SOME APPLICATIONS MAY REQUIRE RUNNING ADDITIONAL TUBING TO THE OUTSIDE OF HVAC UNIT.

**7** T1/T2/T3 ARE 10K TYPE 2 TEMPERATURE PROBE INPUTS. SUPPLY AND RETURN AIR TEMPERATURE PROBES ARE MANDATORY FOR PROPER OPERATION.

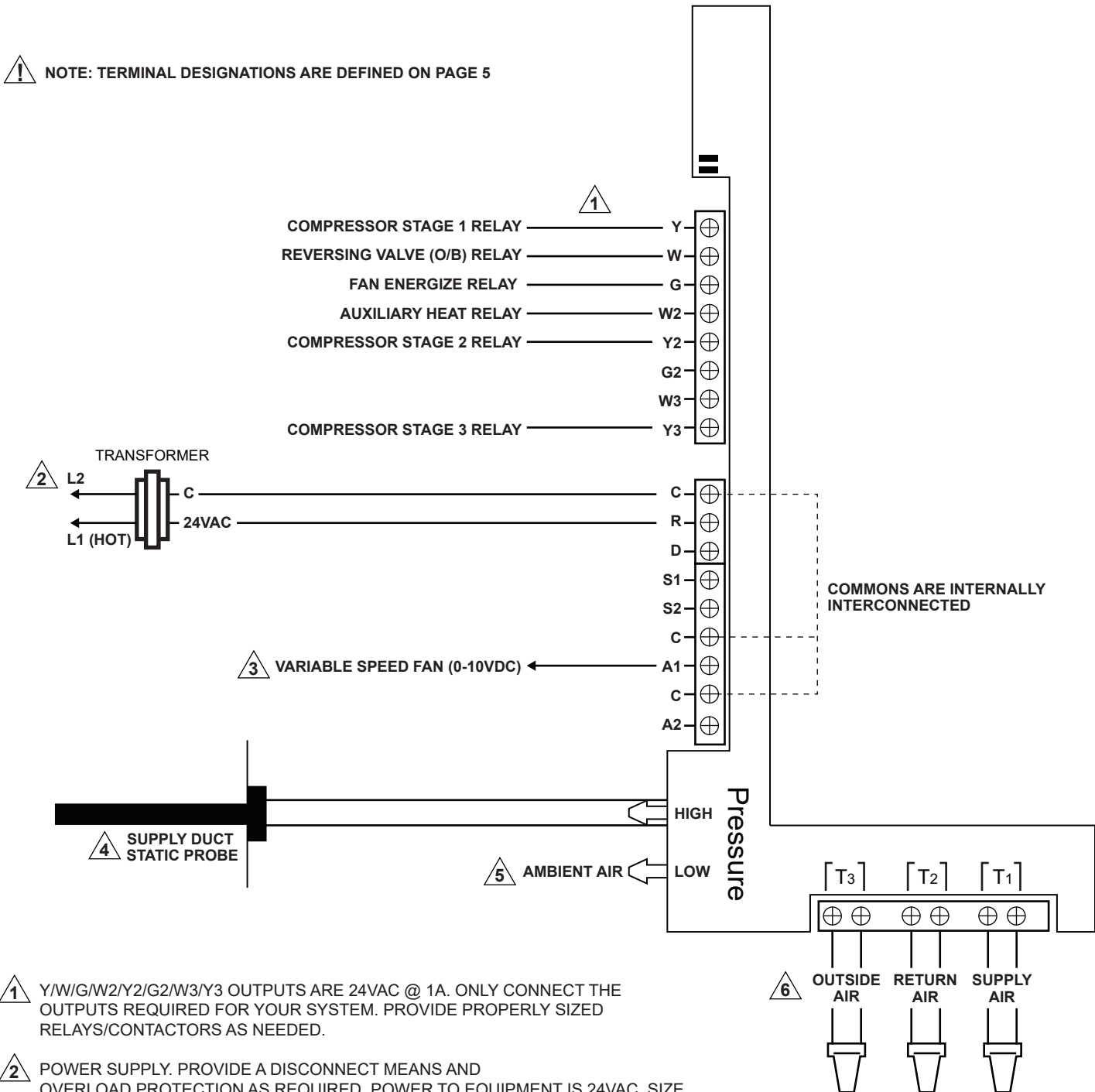
**G2** IF AN EXHAUST FAN IS INSTALLED AND NEEDS TO BE ENERGIZED DURING ECONOMIZATION, CONNECT THE (G2) 24VAC OUTPUT TO THE EXHAUST FAN. PROVIDE PROPERLY SIZED RELAY/CONTACTORS AS NEEDED.

**Fig. 18**

# Variable Speed Fan Wiring Guide (Heat Pump)

The following wiring diagram is for a heat pump with a variable speed fan (VFD).

**NOTE:** TERMINAL DESIGNATIONS ARE DEFINED ON PAGE 5



- 1** Y/W/G/W2/Y2/G2/W3/Y3 OUTPUTS ARE 24VAC @ 1A. ONLY CONNECT THE OUTPUTS REQUIRED FOR YOUR SYSTEM. PROVIDE PROPERLY SIZED RELAYS/CONTACTORS AS NEEDED.
- 2** POWER SUPPLY. PROVIDE A DISCONNECT MEANS AND OVERLOAD PROTECTION AS REQUIRED. POWER TO EQUIPMENT IS 24VAC. SIZE TRANSFORMERS AS NEEDED.
- 3** A1 IS A 0-10VDC OUTPUT FOR MODULATING THE FAN SPEED.
- 4** INSTALL STATIC PROBE IN SUPPLY/DISCHARGE AIR DUCT. RECOMMEND INSTALLATION OF AT LEAST SIX (6) FEET AWAY FROM FAN OR ANY BENDS IN DUCT WORK.
- 5** USED FOR AMBIENT AIR PRESSURE SENSING. SOME APPLICATIONS MAY REQUIRE RUNNING ADDITIONAL TUBING TO THE OUTSIDE OF HVAC UNIT.
- 6** T1/T2/T3 ARE 10K TYPE 2 TEMPERATURE PROBE INPUTS. SUPPLY AND RETURN AIR TEMPERATURE PROBES ARE MANDATORY FOR PROPER OPERATION.

**G** USE THE (G) 24VAC OUTPUT TO ENERGIZE THE FAN. PROVIDE PROPERLY SIZED RELAY/CONTACTORS AS NEEDED.

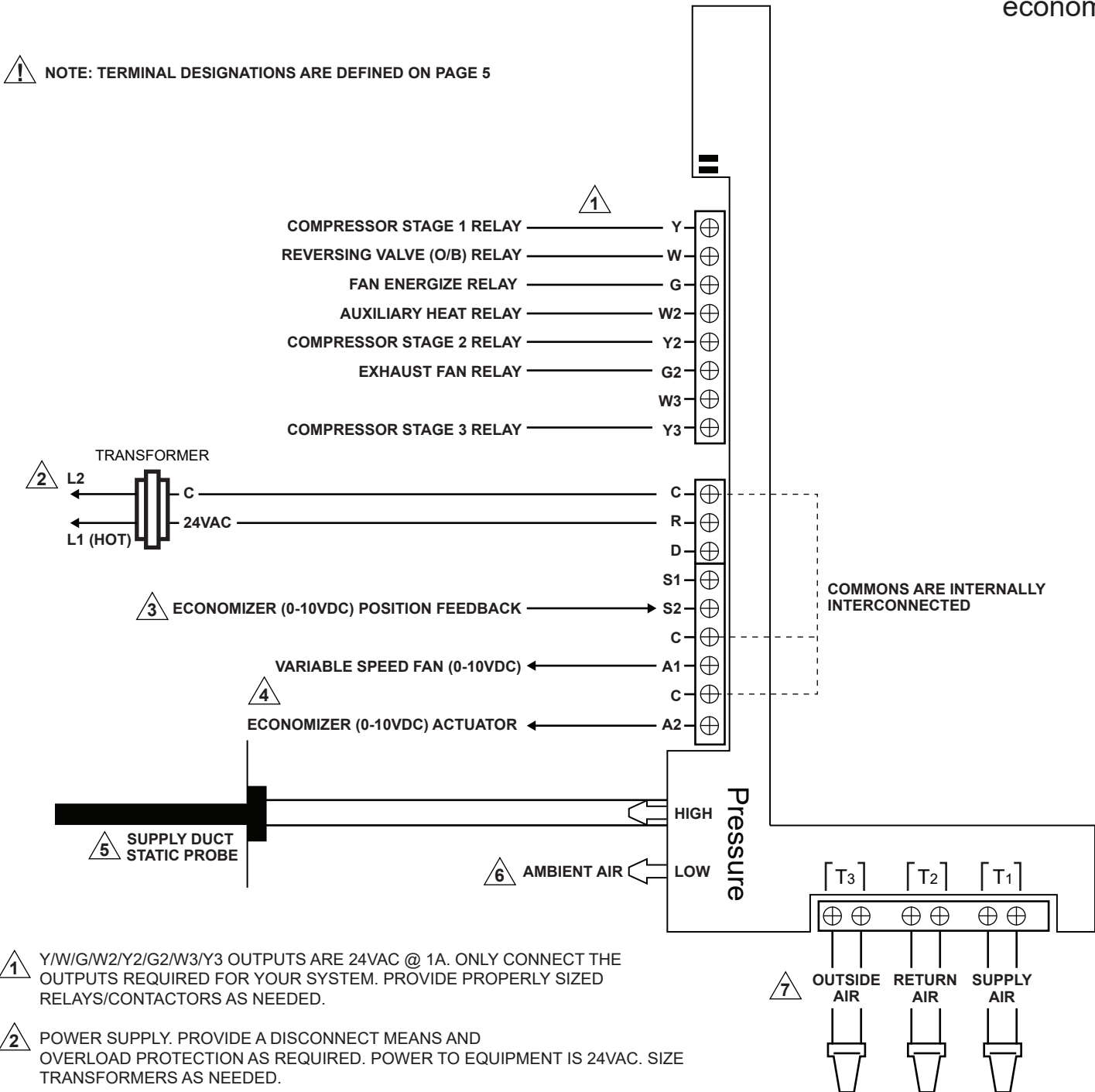
**Fig. 19**



# Variable Speed Fan and Economizer Wiring Guide (Heat Pump)

The following wiring diagram is for a heat pump with a variable speed fan (VFD) and economizer.

**NOTE:** TERMINAL DESIGNATIONS ARE DEFINED ON PAGE 5



**1** Y/W/G/W2/Y2/G2/W3/Y3 OUTPUTS ARE 24VAC @ 1A. ONLY CONNECT THE OUTPUTS REQUIRED FOR YOUR SYSTEM. PROVIDE PROPERLY SIZED RELAYS/CONTACTORS AS NEEDED.

**2** POWER SUPPLY. PROVIDE A DISCONNECT MEANS AND OVERLOAD PROTECTION AS REQUIRED. POWER TO EQUIPMENT IS 24VAC. SIZE TRANSFORMERS AS NEEDED.

**3** S2 IS A 0-10VDC INPUT FOR ECONOMIZER ACTUATOR POSITION FEEDBACK FAULT DETECTION AND DIAGNOSTICS.

**4** A1 IS A 0-10VDC OUTPUT FOR MODULATING THE FAN SPEED. A2 IS A 0-10VDC OUTPUT FOR MODULATING THE ECONOMIZER ACTUATOR.

**5** INSTALL STATIC PROBE IN SUPPLY/DISCHARGE AIR DUCT. RECOMMEND INSTALLATION OF AT LEAST SIX (6) FEET AWAY FROM FAN OR ANY BENDS IN DUCT WORK.

**6** USED FOR AMBIENT AIR PRESSURE SENSING. SOME APPLICATIONS MAY REQUIRE RUNNING ADDITIONAL TUBING TO THE OUTSIDE OF HVAC UNIT.

**7** T1/T2/T3 ARE 10K TYPE 2 TEMPERATURE PROBE INPUTS. SUPPLY AND RETURN AIR TEMPERATURE PROBES ARE MANDATORY FOR PROPER OPERATION.

**G** USE THE (G) 24VAC OUTPUT TO ENERGIZE THE FAN. PROVIDE PROPERLY SIZED RELAY/CONTACTORS AS NEEDED.

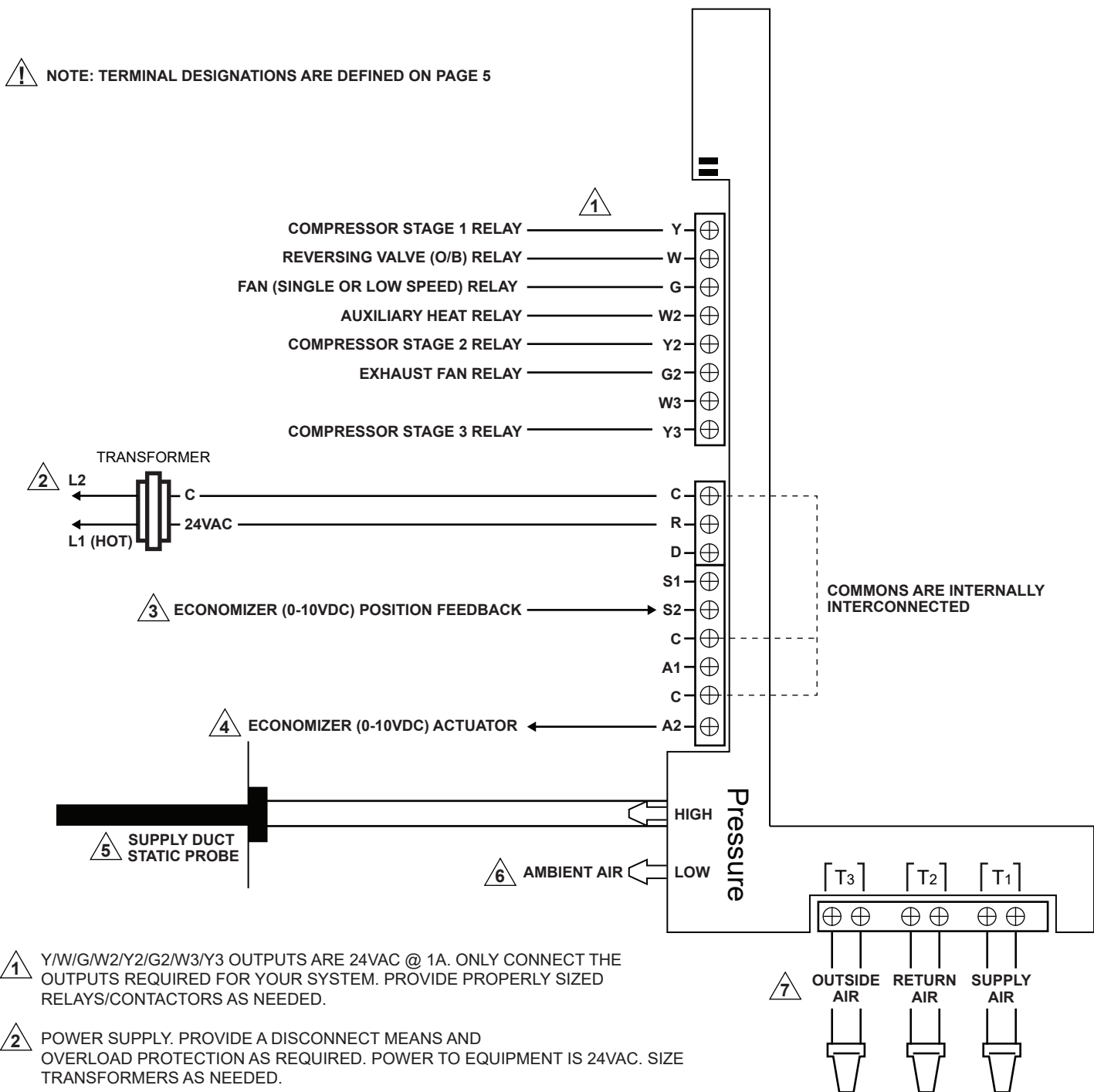
**G2** IF AN EXHAUST FAN IS INSTALLED AND NEEDS TO BE ENERGIZED DURING ECONOMIZATION, CONNECT THE (G2) 24VAC OUTPUT TO THE EXHAUST FAN. PROVIDE PROPERLY SIZED RELAY/CONTACTORS AS NEEDED.

**Fig. 20**

# Economizer Wiring Guide (Heat Pump)

The following wiring diagram is for a heat pump with an economizer.

**NOTE:** TERMINAL DESIGNATIONS ARE DEFINED ON PAGE 5



**1** Y/W/G/W2/Y2/G2/W3/Y3 OUTPUTS ARE 24VAC @ 1A. ONLY CONNECT THE OUTPUTS REQUIRED FOR YOUR SYSTEM. PROVIDE PROPERLY SIZED RELAYS/CONTACTORS AS NEEDED.

**2** POWER SUPPLY. PROVIDE A DISCONNECT MEANS AND OVERLOAD PROTECTION AS REQUIRED. POWER TO EQUIPMENT IS 24VAC. SIZE TRANSFORMERS AS NEEDED.

**3** S2 IS A 0-10VDC INPUT FOR ECONOMIZER ACTUATOR POSITION FEEDBACK FAULT DETECTION AND DIAGNOSTICS.

**4** A2 IS A 0-10VDC OUTPUT FOR MODULATING THE ECONOMIZER ACTUATOR.

**5** INSTALL STATIC PROBE IN SUPPLY/DISCHARGE AIR DUCT. RECOMMEND INSTALLATION OF AT LEAST SIX (6) FEET AWAY FROM FAN OR ANY BENDS IN DUCT WORK.

**6** USED FOR AMBIENT AIR PRESSURE SENSING. SOME APPLICATIONS MAY REQUIRE RUNNING ADDITIONAL TUBING TO THE OUTSIDE OF HVAC UNIT.

**7** T1/T2/T3 ARE 10K TYPE 2 TEMPERATURE PROBE INPUTS. SUPPLY AND RETURN AIR TEMPERATURE PROBES ARE MANDATORY FOR PROPER OPERATION.

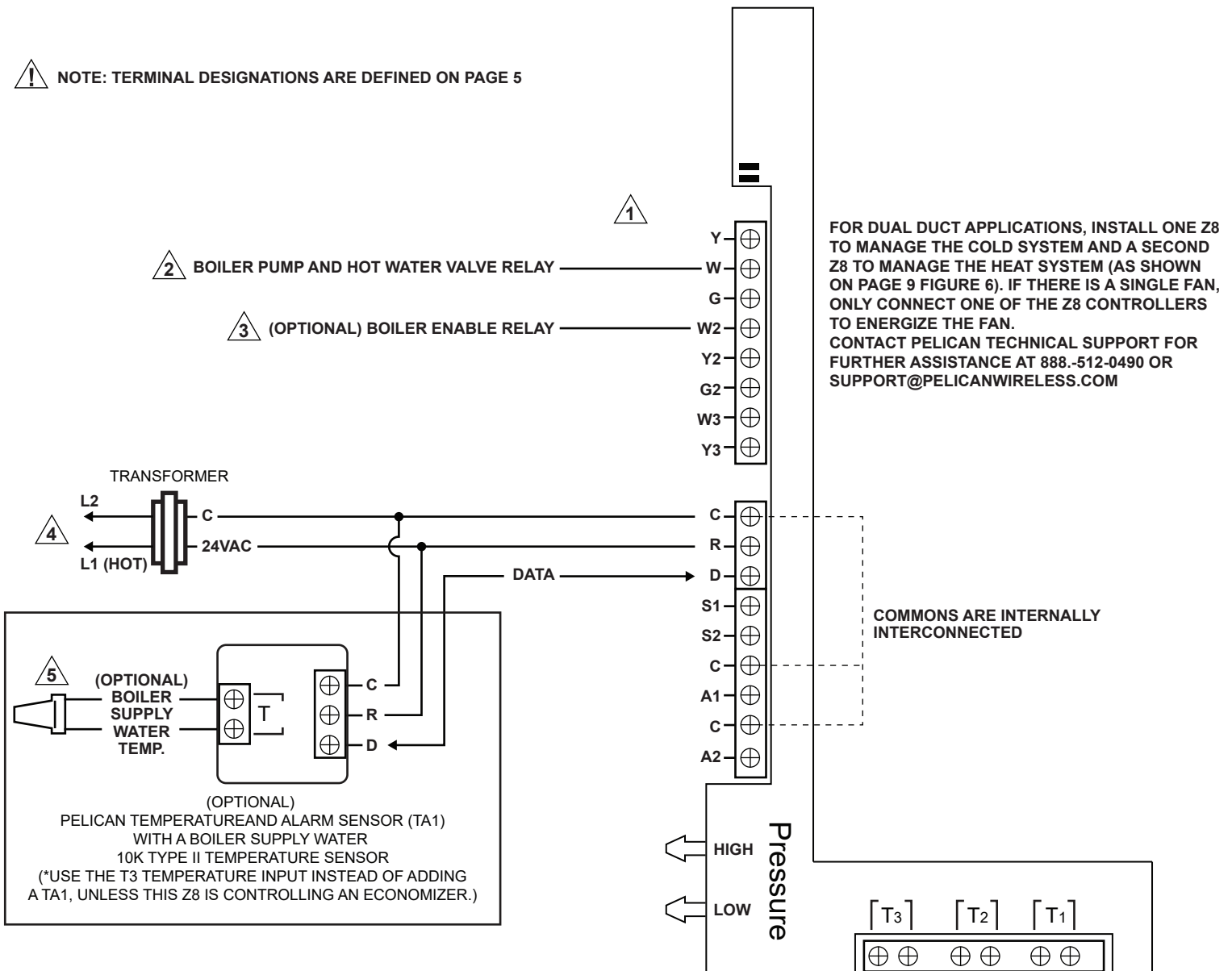
**G2** IF AN EXHAUST FAN IS INSTALLED AND NEEDS TO BE ENERGIZED DURING ECONOMIZATION, CONNECT THE (G2) 24VAC OUTPUT TO THE EXHAUST FAN. PROVIDE PROPERLY SIZED RELAY/CONTACTORS AS NEEDED.

**Fig. 21**

# Boiler Wiring Guide

The following wiring diagram is for energizing a boiler.

**⚠ NOTE: TERMINAL DESIGNATIONS ARE DEFINED ON PAGE 5**



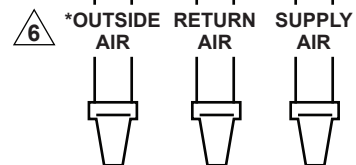
**1** Y/W/G/W2/Y2/G2/W3/Y3 OUTPUTS ARE 24VAC @ 1A. ONLY CONNECT THE OUTPUTS REQUIRED FOR YOUR SYSTEM. PROVIDE PROPERLY SIZED RELAYS/CONTACTORS AS NEEDED.

**2** ON HEAT DEMAND (W) WILL ENERGIZE THE PUMP(S) AND/OR VALVE(S).

**3** (W2) IS OPTIONAL AND REQUIRES A BOILER SUPPLY WATER TEMPERATURE PROBE. IF A SUPPLY WATER TEMPERATURE PROBE IS BEING USED, ENABLE BOILER CONTROL WHEN CONFIGURING THE Z8. WITH BOILER CONTROL ENABLED, THE Z8 WILL MONITOR THE LEAVING HOT WATER TEMPERATURE AND WILL WAIT UNTIL THE TEMPERATURE IS WITHIN A CONFIGURABLE RANGE BEFORE ENERGIZING (W).

**4** POWER SUPPLY. PROVIDE A DISCONNECT MEANS AND OVERLOAD PROTECTION AS REQUIRED. POWER TO EQUIPMENT IS 24VAC. MULTIPLE TRANSFORMERS CAN BE USED. SIZE TRANSFORMERS AS NEEDED.

**5** (OPTIONAL) INSTALL A PELICAN TA1 AND A 10K TYPE 2 TEMPERATURE PROBE DESIGNED AND RATED TO READ THE SUPPLY WATER TEMPERATURE OF THE BOILER. TEMPERATURE DETECTION RANGE -20 DEG. F TO 180 DEG. F. USE THE T3 TEMPERATURE INPUT INSTEAD OF A TA1, UNLESS THIS Z8 IS CONTROLLING AN ECONOMIZER.



**6** T1/T2/T3 ARE 10K TYPE 2 TEMPERATURE PROBE INPUTS. SUPPLY AND RETURN AIR TEMPERATURE PROBES ARE MANDATORY FOR PROPER OPERATION. \*USE THE T3 TEMPERATURE INPUT INSTEAD OF A TA1 TO DETECT BOILER SUPPLY WATER TEMPERATURE IF THERE IS NO ECONOMIZER.

**⚠** IF USING OPTION **3** AND **5** FOLLOW CONFIGURATION OPTION ON PAGE 32 - BOILER CONTROL. DO NOT ENABLE BOILER CONTROL IF NO USING OPTION **3** AND **5** FROM ABOVE.

**Fig. 22**

# Configuration

## 1

### PELICAN WEB APP

To configure a new Pelican Z8, navigate to your building's Pelican Web App through any web browser (Google Chrome, Apple Safari, Microsoft Edge, etc.). All configuration is done through your Pelican Web App. To create a Pelican Web App you will need a Pelican Gateway (GW400). For further information on the Pelican Gateway (GW400) visit [www.PelicanWireless.com](http://www.PelicanWireless.com).

## 2

### SERIAL NUMBER

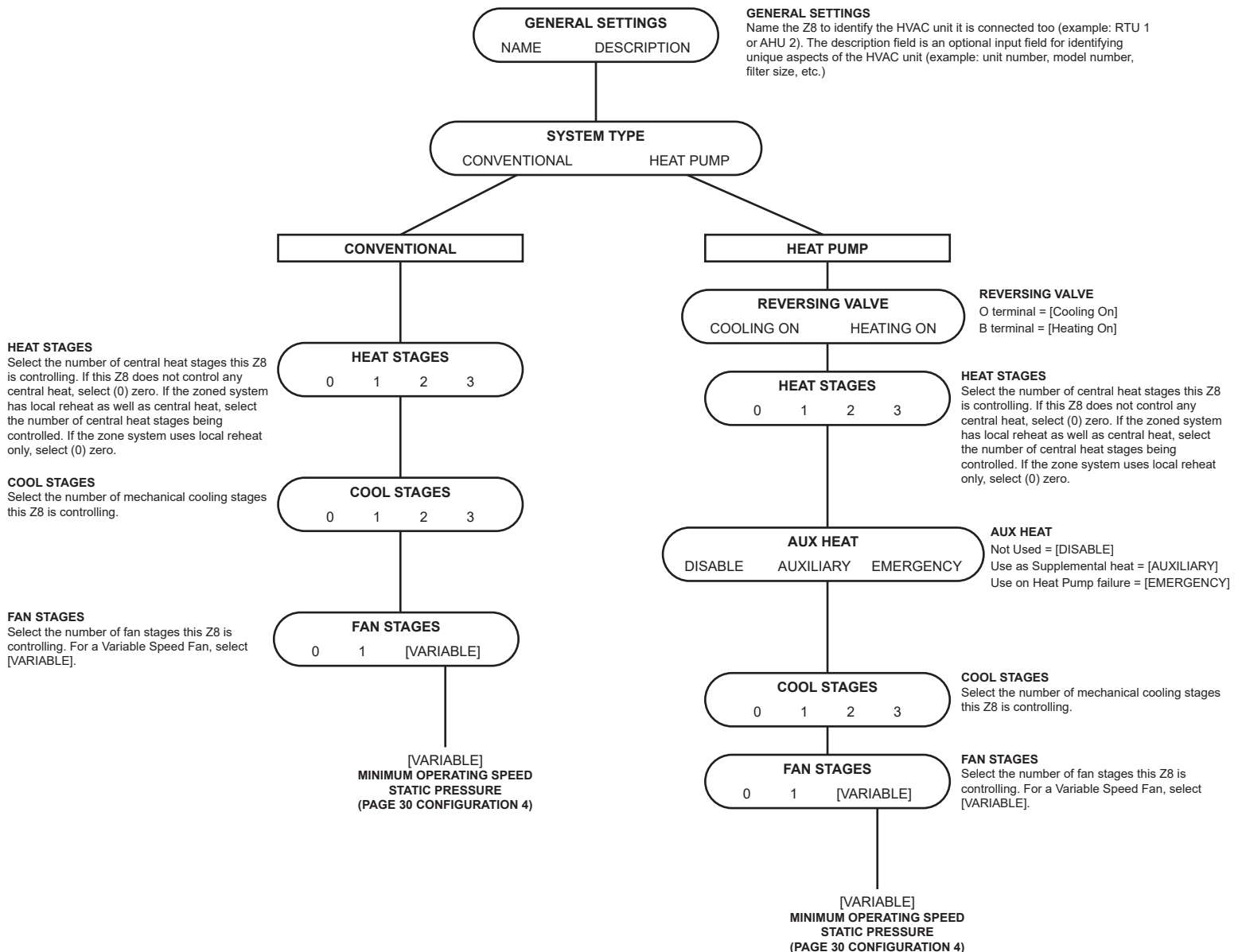
Each Pelican Z8 has a unique identification serial number. This serial number can be found on the front of the Z8's Wireless Antenna. With the Serial Number recorded, find the new notification on your Pelican Web App which matches the serial number on the Z8's Wireless Antenna. Press configure.

If no new notification is found, select Admin and identify if the new Z8 is on your Pelican Web App. If the Z8 is not found under Admin, then the Z8 is unable to communicate with the wireless gateway. Go to Page 22 for Troubleshooting.

## 3

### SYSTEM CONFIGURATION OPTIONS

The following flow chart illustrates Z8 configuration options.

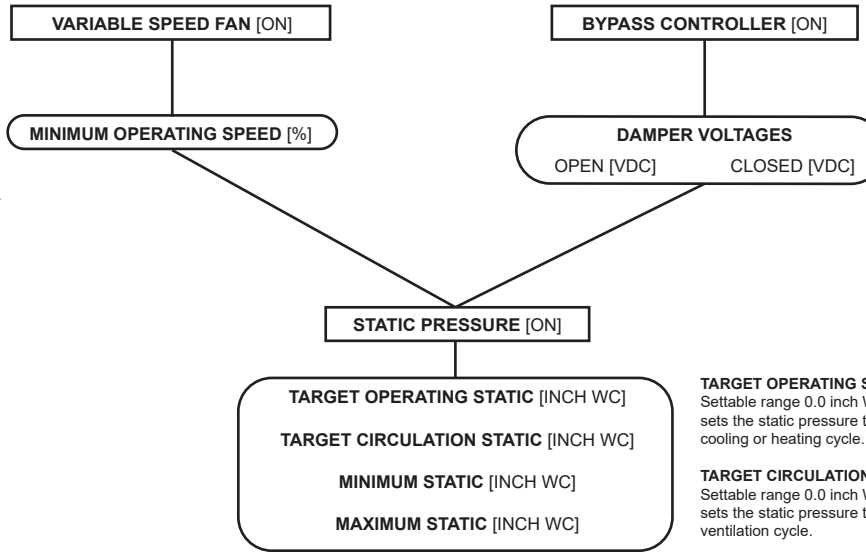


# 4

## STATIC MANAGEMENT CONFIGURATION OPTIONS

The following flow chart illustrates Z8 static configuration options.

**MINIMUM OPERATING SPEED**  
 Settable range 0% to 100% of maximum fan speed. Configure to the slowest fan speed allowed for proper operation of the mechanical equipment.  
 Output: 0% = 0.0VDC  
 100% = 10.0VDC



**DAMPER VOLTAGE**  
 Settable range is from 0 to 10 VDC. Adjust the settings to match the actual OPEN/CLOSED end of travel positions of the actuator being used.

**TARGET OPERATING STATIC**  
 Settable range 0.0 inch WC to 3.0 inch WC. This sets the static pressure targeted when running a cooling or heating cycle.

**TARGET CIRCULATION STATIC**  
 Settable range 0.0 inch WC to 3.0 inch WC. This sets the static pressure targeted when running a ventilation cycle.

**MINIMUM STATIC**  
 Settable range 0.0 inch WC to 3.0 inch WC. This is a safety and will place the Z8 into an automatic reset if detected during a heating, cooling or reheat cycle. Reset will de-energize any calls for heating, cooling, or reheat, but the call for fan will remain energized. The Z8 will restart the heating, cooling, or reheat cycle after ten minutes.

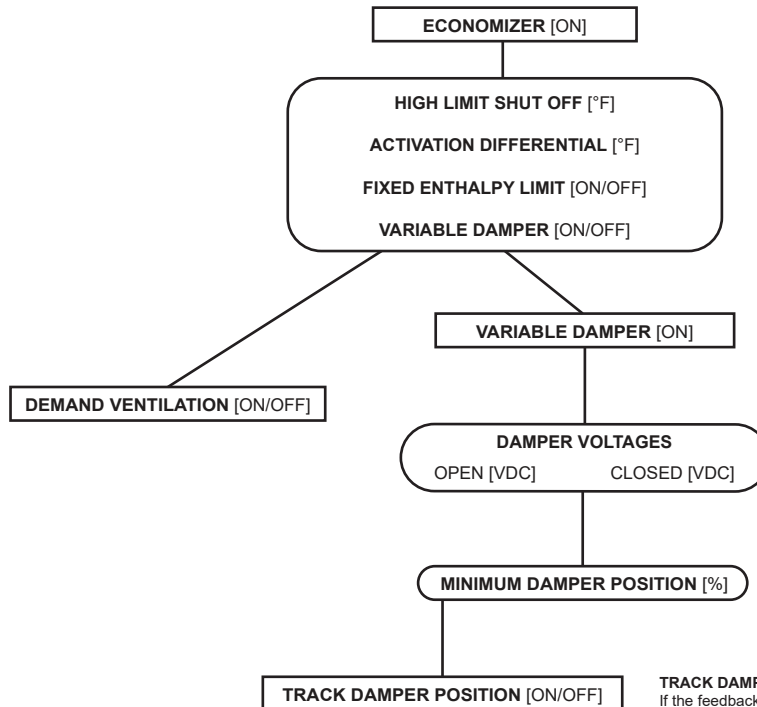
**MAXIMUM STATIC**  
 Settable range 0.0 inch WC to 3.0 inch WC. This is a safety and will place the Z8 into an automatic reset if detected during a heating, cooling, reheat, or ventilation cycle. Reset will de-energize all calls. Z8 will restart heating, cooling, reheat, or ventilation cycle after ten minutes.

# 5

## ECONOMIZER CONFIGURATION OPTIONS

The following flow chart illustrates Z8 economizer configuration options.

**DEMAND VENTILATION**  
 If a Pelican Zone Thermostat with an integrated CO2 sensor is installed and you would like the Z8 to provide demand ventilation based on CO2, turn this feature ON.



**HIGH LIMIT SHUT OFF**  
 Sets the warmest air allowed for economization. If left blank, the Z8 will auto-calculate the high limit shut off. Settable range of -20°F to 180°F.

**ACTIVATION DIFFERENTIAL**  
 Requires the outside air temperature to be at least this many degrees below the return air temperature to be used for economization. Settable range 0°F to 6°F.

**FIXED ENTHALPY**  
 Set to ON if the economizer should be disabled if the outside enthalpy levels exceeds 28 Btu/lb. (No enthalpy probe required to use).

**DAMPER VOLTAGES**  
 Settable range is from 0 to 10 VDC. Verify settings match actual actuator OPEN/CLOSED positions.

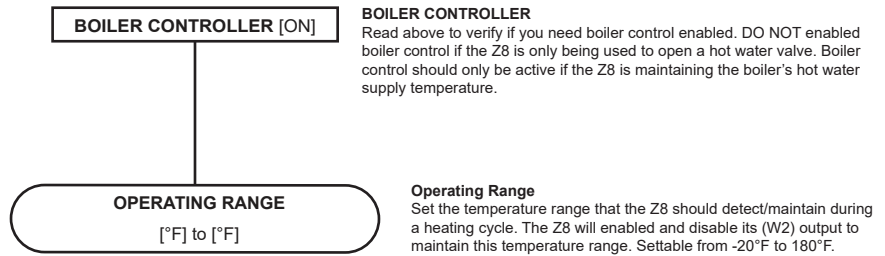
**MINIMUM DAMPER POSITION**  
 Settable range is from 0% to 100% of the maximum damper open position.

**TRACK DAMPER POSITION**  
 If the feedback input on the Z8 is being used for economizer damper position feedback, turn this feature ON. This will enable fault detection and diagnostics. In some States fault detection and diagnostics are required to meet energy codes. Check with your local and State codes to determine if this is required for your installation.

# 7

## BOILER CONFIGURATION OPTIONS

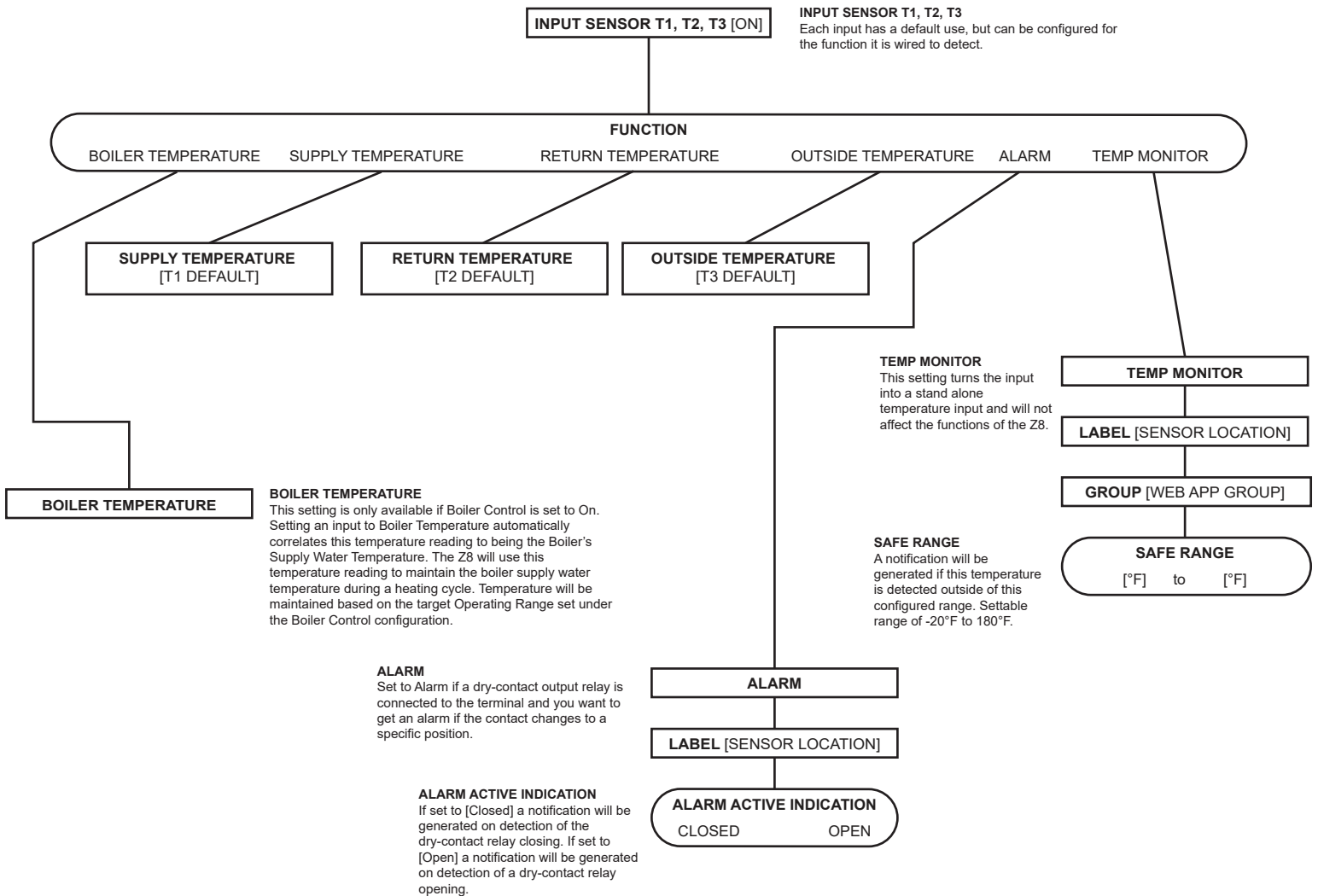
By enabling boiler control you are instructing the Z8 to use (W2) as a boiler enable output. With this feature active, the Z8 will NOT energize (W) until it detects the boiler's supply water temperature to be within a specified range. This feature requires the Z8 to be able to read the boiler's hot water supply temperature. Reference the boiler installation guide on page 27 of this document and contact Pelican Technical Support for further assistance.



# 8

## INPUT SENSOR CONFIGURATION OPTIONS

The following flow chart illustrates Z8 input sensor configuration options.



# Z8 Troubleshooting

## Troubleshoot Internet Status and Wireless Signals

**Wireless Status:**  
Off - Initializing  
1 Second Blink - Establishing Wireless Connection  
Solid - Communicating Over Wireless

**Internal Status:**  
Off - No Power  
1 Second Blink - Initializing  
Solid - Operational

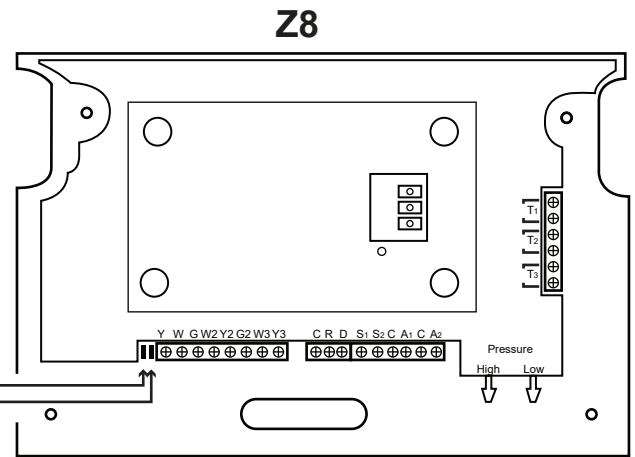


Fig. 23

## Wireless Module

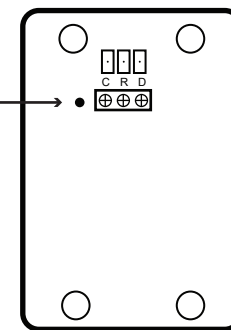


Fig. 24

**Wireless Connection Identifier:**  
Off - No Power  
1 Second Blink - Establishing Wireless Connection  
Blink Every 15 sec - Communicating Over Wireless

## TROUBLESHOOT Z8 CONTROL OUTPUTS

ON YOUR PELICAN SITE MANAGER YOU CAN TEST THE SIGNAL OUTPUTS OF THE Z8 TO PROVIDE IMMEDIATE FEEDBACK THAT EACH OF THE Z8's OUTPUTS ARE CONTROLLING THE CORRECT INSTALLED EQUIPMENT.

THESE OPTIONS LET YOU MANUALLY TURN ON AND OFF THE CONTROL SIGNALS. IT ALSO ALLOWS YOU TO DYNAMICALLY ADJUST ALL 0-10VDC OUTPUTS FOR TESTING A VARIABLE SPEED FAN, MODULATING BYPASS DAMPER ACTUATOR, AND MODULATING ECONOMIZER DAMPER. WHEN TESTING 0-10VDC OUTPUTS SET VFD, BYPASS AND ECONOMIZER CONTROL TO "OFF".

**IMPORTANT: THE SIGNAL OUTPUT CONTROL IS A MASTER OVERRIDE FEATURE. ALWAYS MAKE SURE SYSTEMS ARE OFF BEFORE ACTIVATING A MANUAL SIGNAL OUTPUT ADJUSTMENT. WHEN FINISHED TESTING SET ALL OUTPUTS BACK TO THE POSITION THEY WERE ORIGINALLY IN.**



# **Pelican** *Wireless Systems*

2655 Collier Canyon Road  
Livermore, CA 94550

Phone: 888-512-0490

eMail: [sales@pelicanwireless.com](mailto:sales@pelicanwireless.com)  
[support@pelicanwireless.com](mailto:support@pelicanwireless.com)

Web: [www.pelicanwireless.com](http://www.pelicanwireless.com)

**37-0012 Version 2**  
© All Rights Reserved. Pelican Wireless Systems, LLC.